

Les méthodes actuelles / outils pour caractériser le danger d'incendie, le comportement et les risques

Michele Salis

University of Sassari, Dept. of Science for Nature and Environmental Resources (DIPNET);

Euro-Mediterranean Center on Climate Change – IAFES Division of Sassari

miksalis@uniss.it



« PREMIER ATELIER SUR LES
INCENDIES DE FORET ET LE
CHANGEMENT CLIMATIQUE »

11-12 Janvier 2016, Dar el Beida (Alger)

Increased frequency of extreme weather

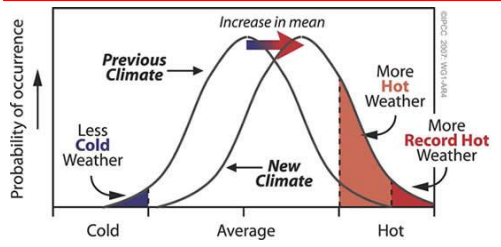

Lengthening of fire seasons



Land use / land cover changes



Loss of confidence in using agricultural fires



**MEDITERRANEAN AREAS:
INCREASE IN FIRE RISK
AND MEGA-FIRE
FREQUENCY**



Increased pressure in coastal and urban areas



Increment of fire suppression budgets



Lacking land management and build-up of unmanaged fuelbeds



Ageing population in forest/rural areas

Foreword

The growing incidence of large fires impacting forests and urban interfaces over the past decades has led to extensive research on wildfire risk

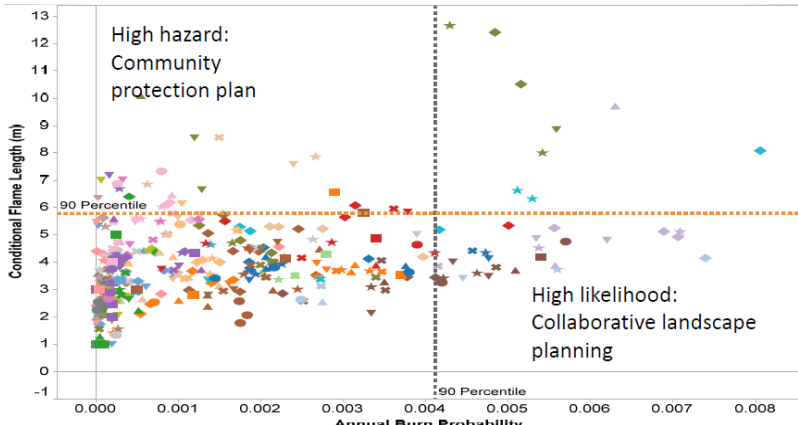
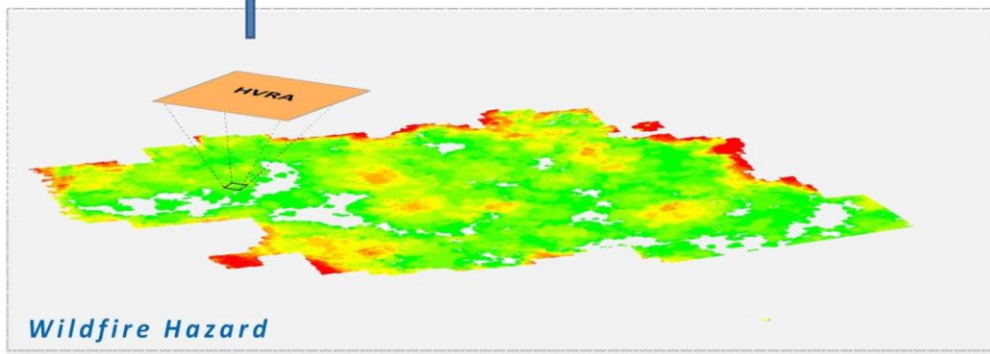
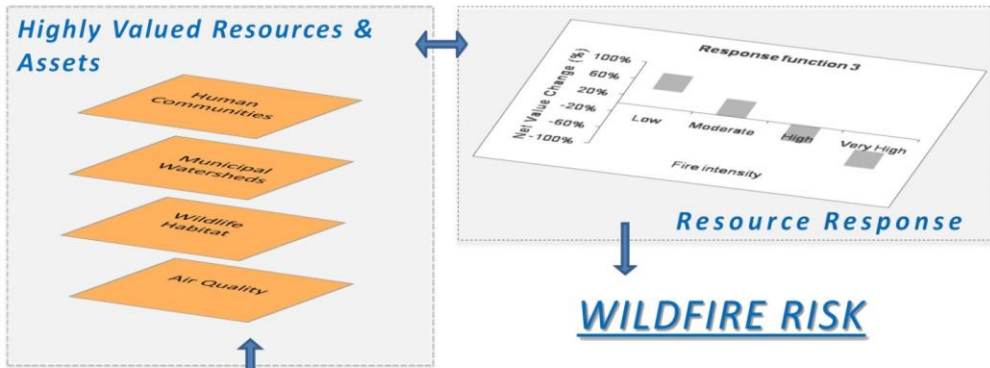
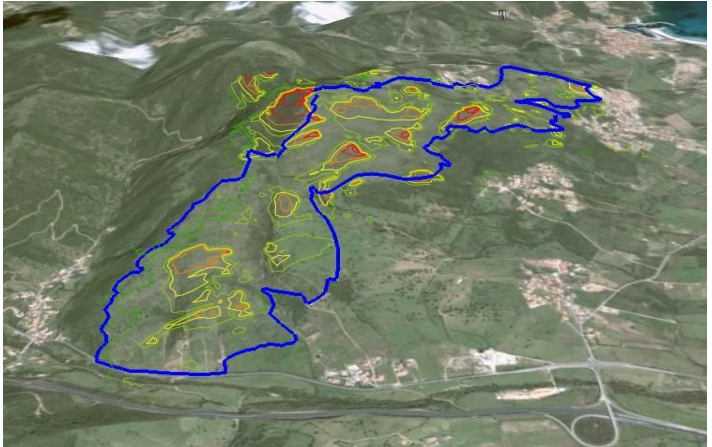

- | | | | | |
|-----------------|-------------|------------|---------|------------|
| Forest | Colville | Mt. Baker | Siuslaw | Willamette |
| Crooked River | Mt. Hood | Snoqualmic | Winema | |
| Deschutes | Ochoco | Umatilla | | |
| Fremont | Okanogan | Umpqua | | |
| Gifford Pinchot | Olympic | Wallowa | | |
| Kaniksu | Rogue River | Wenatchee | | |
| Malheur | Siskiyou | Whitman | | |
-
- | | |
|--------------------|---------------------|
| WUI | High_Dens_Interface |
| High_Dens_Intermix | Low_Dens_Interface |
| Low_Dens_Intermix | Med_Dens_Interface |
| Med_Dens_Intermix | Very_Low_Dens_Veg |

Foreword

Simulation models and tools are now routinely used to analyze potential fire behavior and develop risk assessment and mitigation strategies, over a range of scales, from forest stands (few hectares) to very large landscapes (thousand km²)

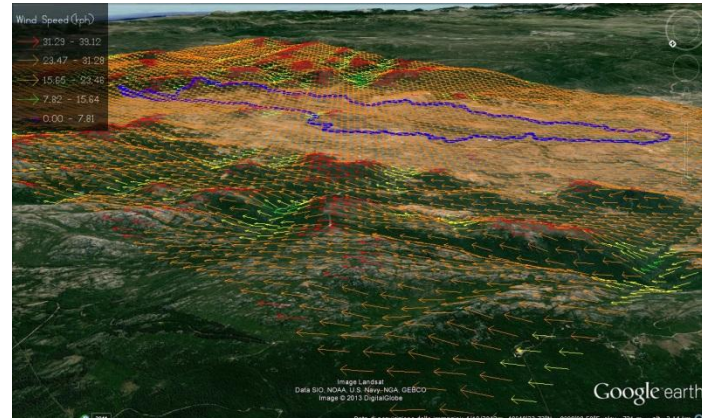
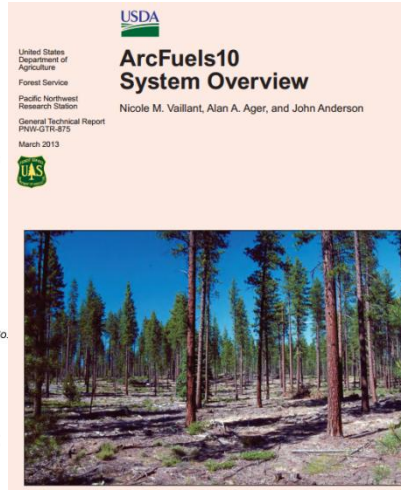
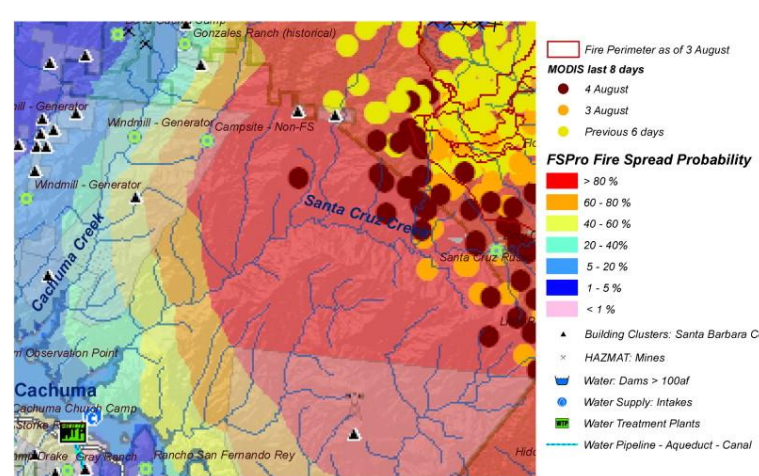

Foreword

Quantifying Risk for Wildfire Management

Definition of Risk

- Risk is the chance that «something bad» will happen
- It combines likelihood with effects
- It is an expectation, and therefore units are expectations (€, \$, hectares, people, things, etc.)
- Developed for disaster management and insurance where uncertainty is high (e.g.: large wildfires)



(Ager 2013)

Foreword

Quantifying Risk for Wildfire Management

Wildfire Risk = probability of a fire of a specific intensity x the loss at that intensity;
often called expected loss

$$E(L) = \sum_i p(f_i) * R(f_i)$$

with...

$p(f_i)$ = Probability of burning intensity level i “Exposure”

$R(f_i)$ = Response for intensity i “Susceptibility”

$E(L)$ = Expected loss “Risk”

(Finney 2013)

We sum over i because fire can arrive at many intensities at a particular location

Definition of Disaster Risk for IPCC

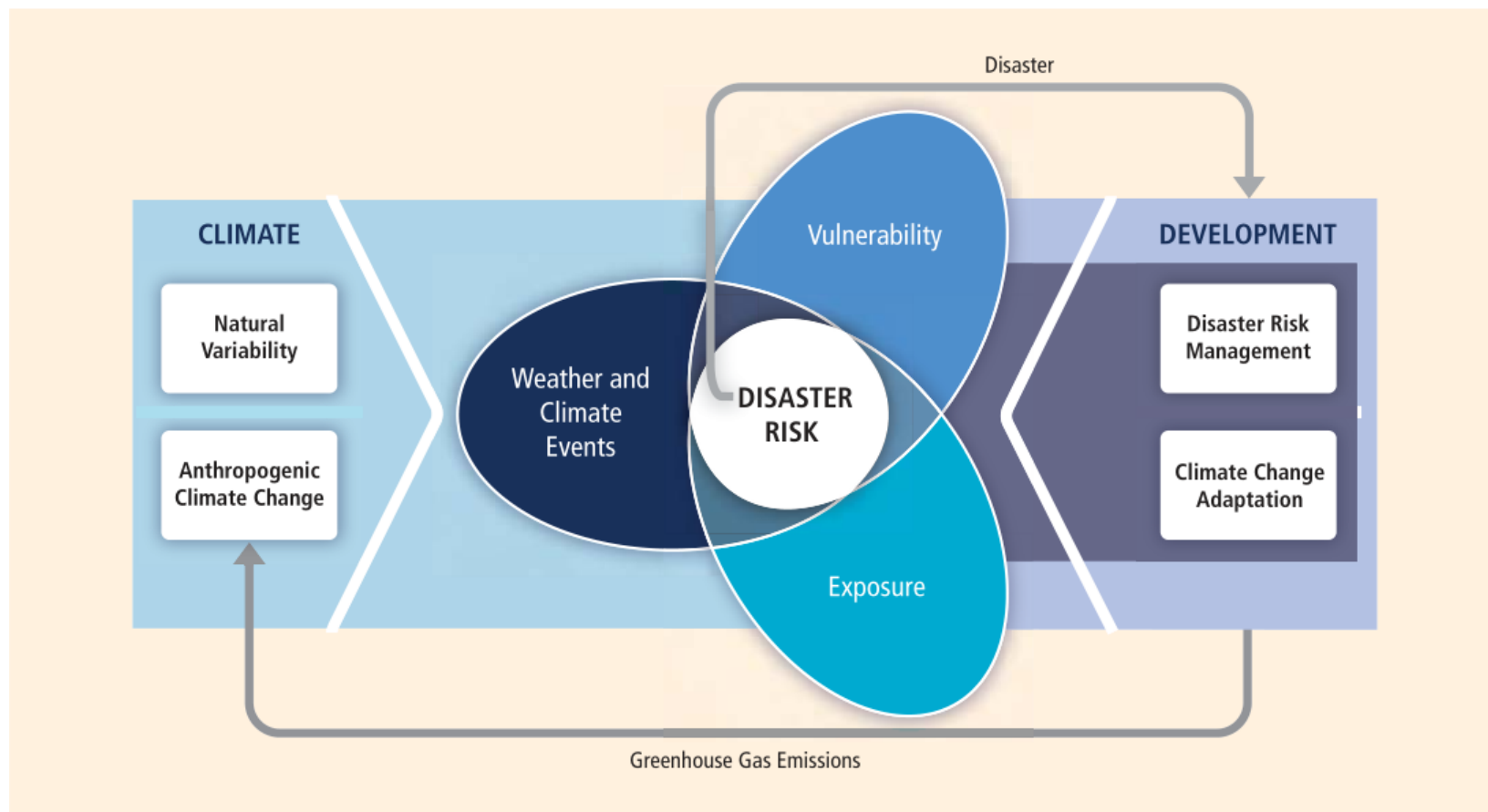

The key concepts and scope of the IPCC report (2013). The figure indicates schematically key concepts involved in disaster risk management and climate change adaptation, and the interaction of these with sustainable development

Foreword

Quantifying Risk for Wildfire Management

How do we estimate fire exposure and vulnerability?

$$E(L) = \sum_i p(f_i) * R(f_i)$$

Historical wildfire data and reports are generally insufficient to map burn probability and intensity at fine scales

In recent years, several studies have used fire models

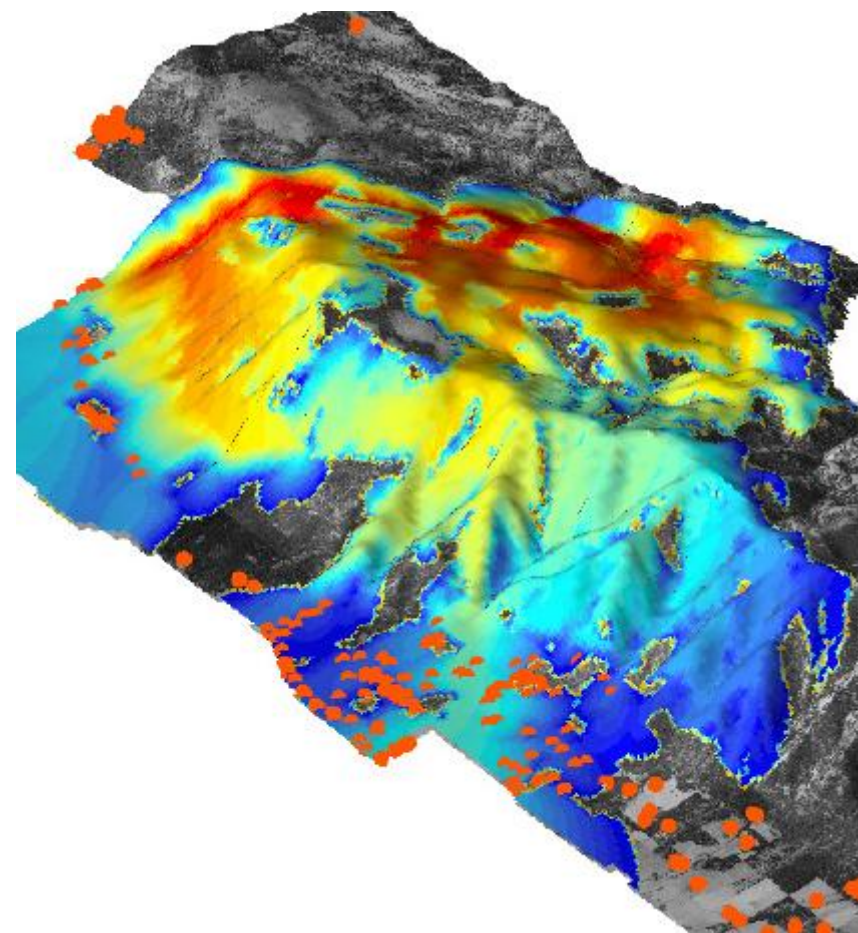

Foreword

What is a model?

a) A model is a simplification of reality, and is based on a set of assumptions



Foreword

What is a model?

b) All models are wrong (only reality is right)

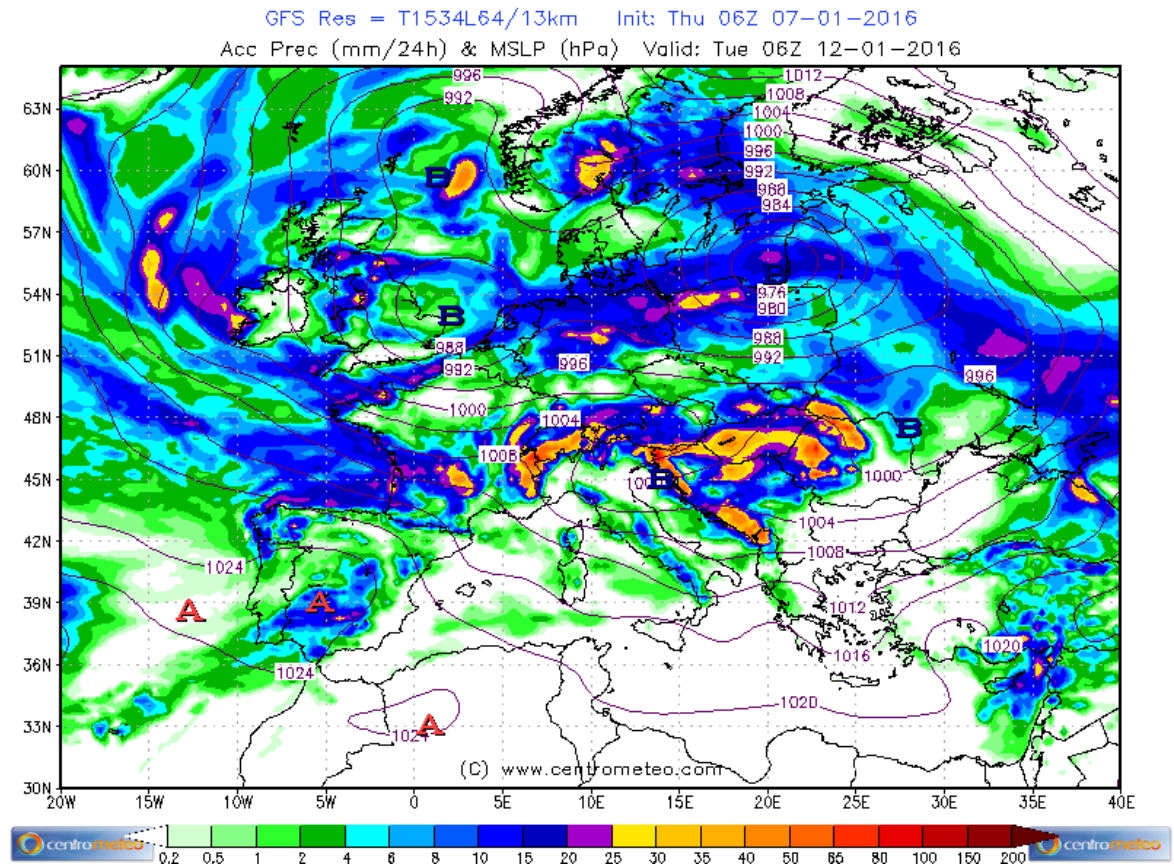

Foreword

What is a model?

c) More complicated models are not necessarily better

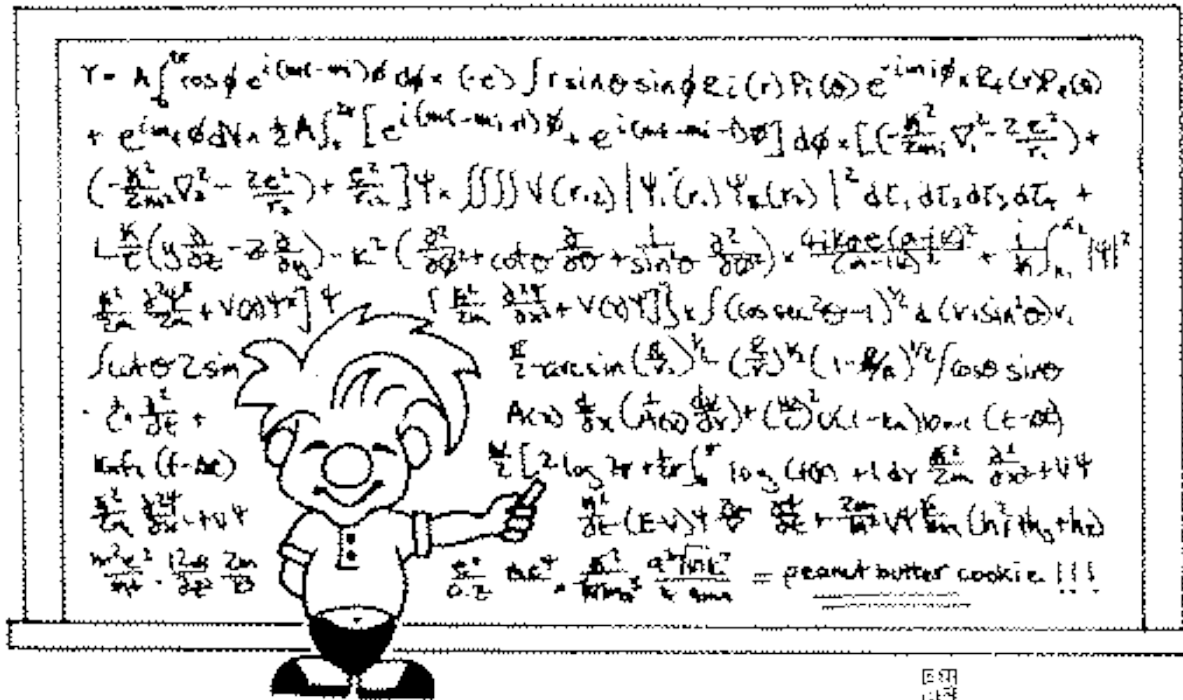

Foreword

What is a model?

d) Specific Purpose

- ❑ Practical, for operational prediction (easy to use for most people, practical set of inputs, limited run times, useful for training)
- ❑ Research models, for fundamental understandings (used to understand how things work, high run times, high performance computers, not easy for «standard» users)



Foreword

What is a model?

- e) Models can be useful even if fundamentals are wrong
- f) Models can be made to produce anything we want

Foreword

Different kind of models

Physical Models (Theoretical)

- ~ Physical framework
- ~ Based on known theoretical relations
- ~ Fine-scale processes compared to scale of prediction
- ~ Many processes with explicit assumptions
- ~ Many parameters can't be known

Empirical Models (Statistical)

- ~ Observations (laboratory or field), related statistically to predictive variables
- ~ At the scale of the phenomena
- ~ Useful within the range of conditions developed under
- ~ Cannot be used for other phenomena

Semi-Empirical Models

All fire models are based on some empiricism!

(Finney 2013)

Foreword

Fire risk modeling is a process with several steps

First of all...

- a) Define the **objective** or question that is relevant for your purpose;
- b) Evaluate if modeling is **necessary** or not
- c) Gather spatial and temporal data of your study area, and evaluate **input quality and consistence**
- d) Check if the model inputs correspond to the data collected
- d) Analyze what are the **model outputs** and if they can help answering your objective or questions
- e) **Select the fire model**

Foreword

Fire risk modeling is a process with several steps

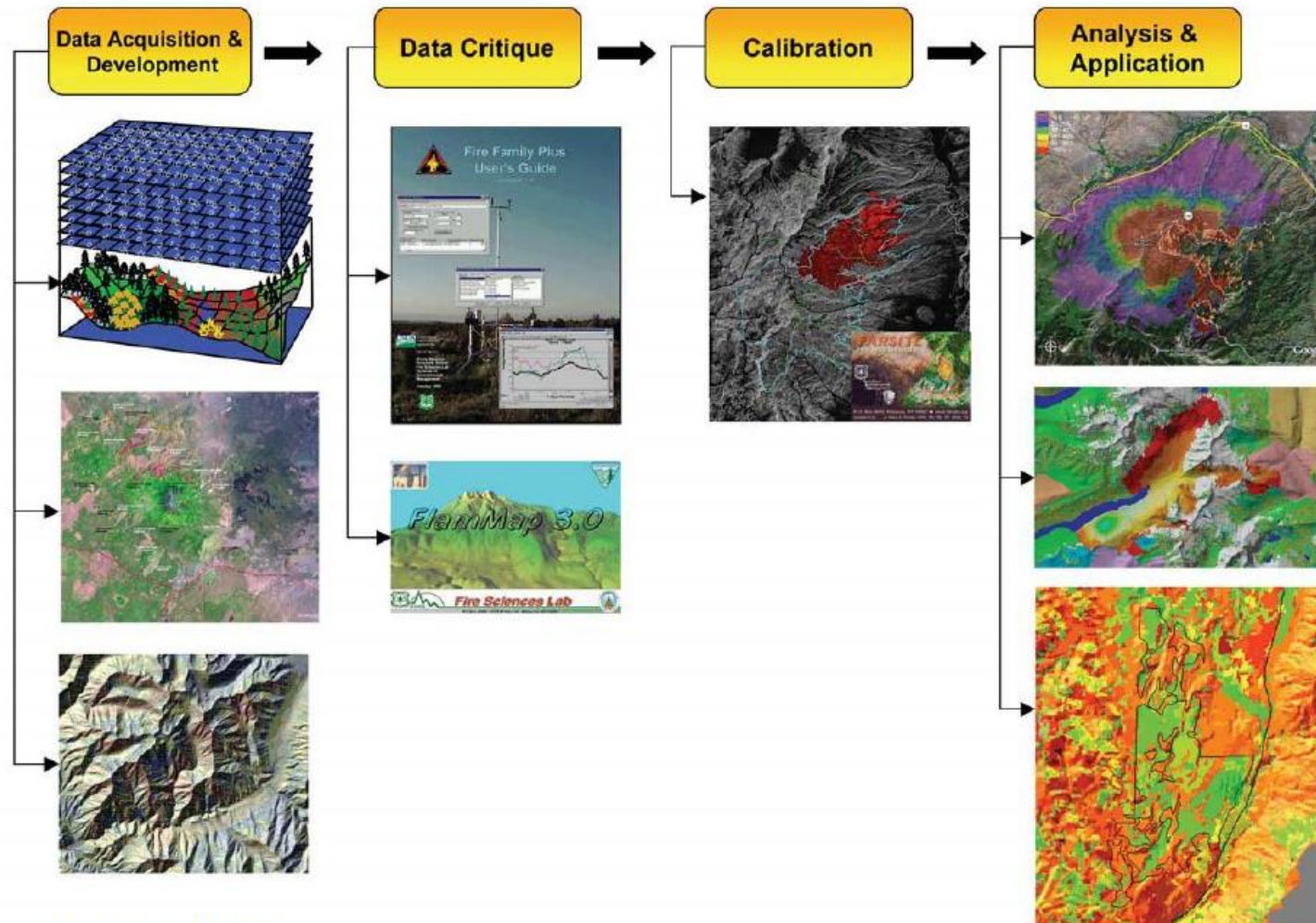

Foreword

Fire risk modeling is a process with several steps

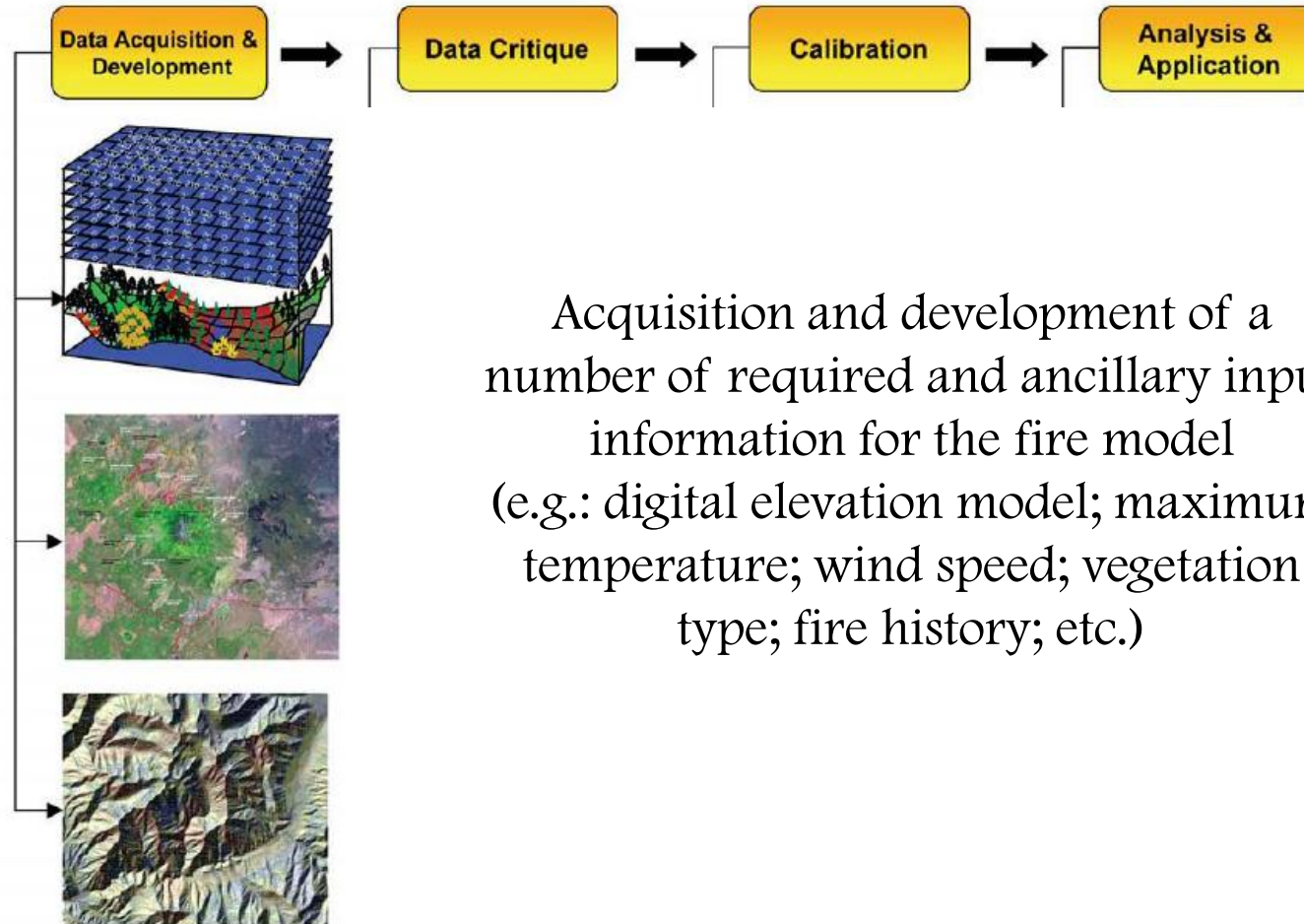

Foreword

Fire risk modeling is a process with several steps

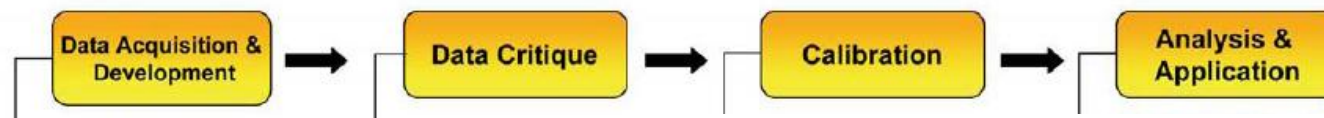

Critical analysis of the limitations, errors, gaps, and simplifications of the data used as inputs for the model and of the outputs obtained

Foreword

Fire risk modeling is a process with several steps

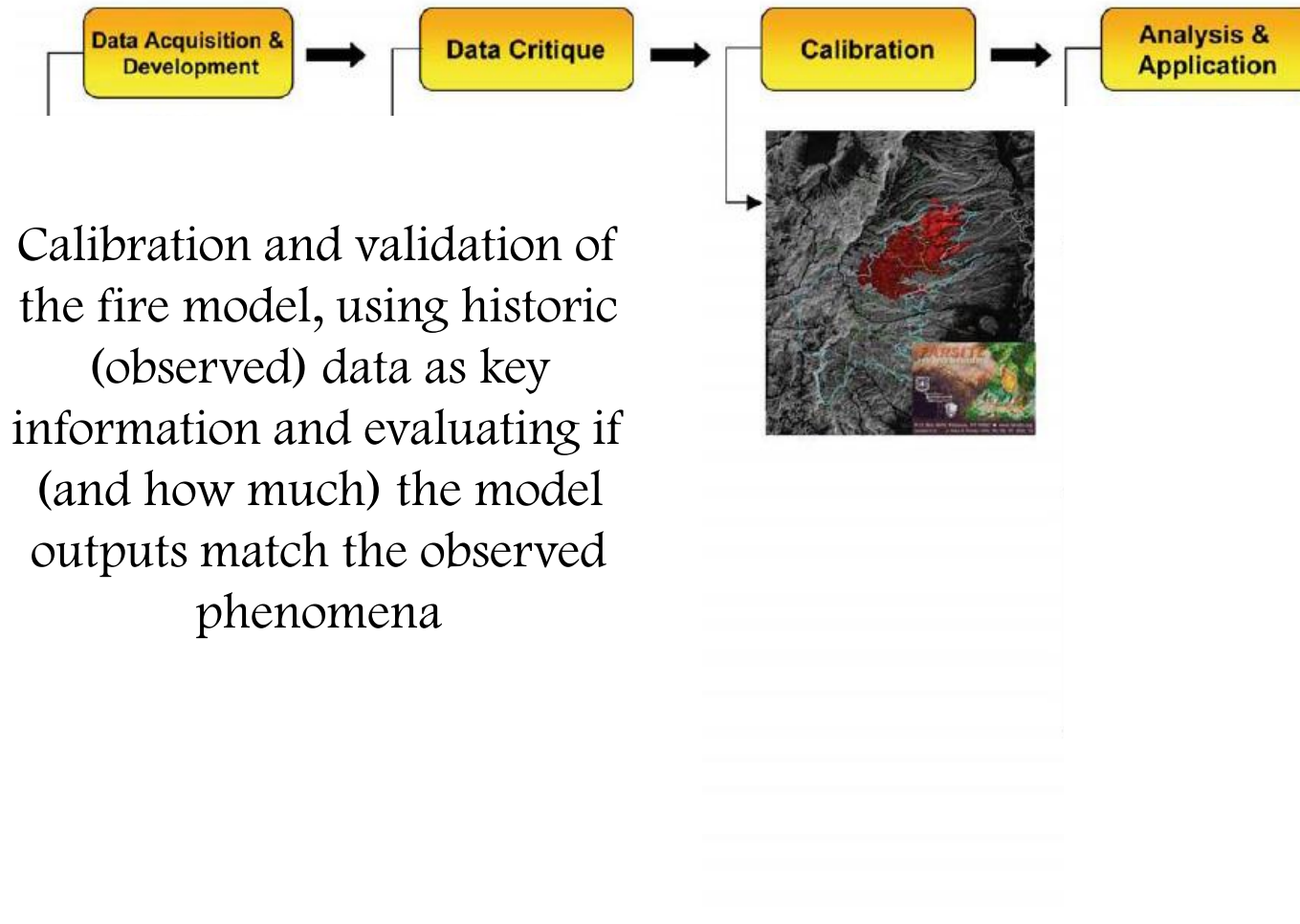

Foreword

Fire risk modeling is a process with several steps

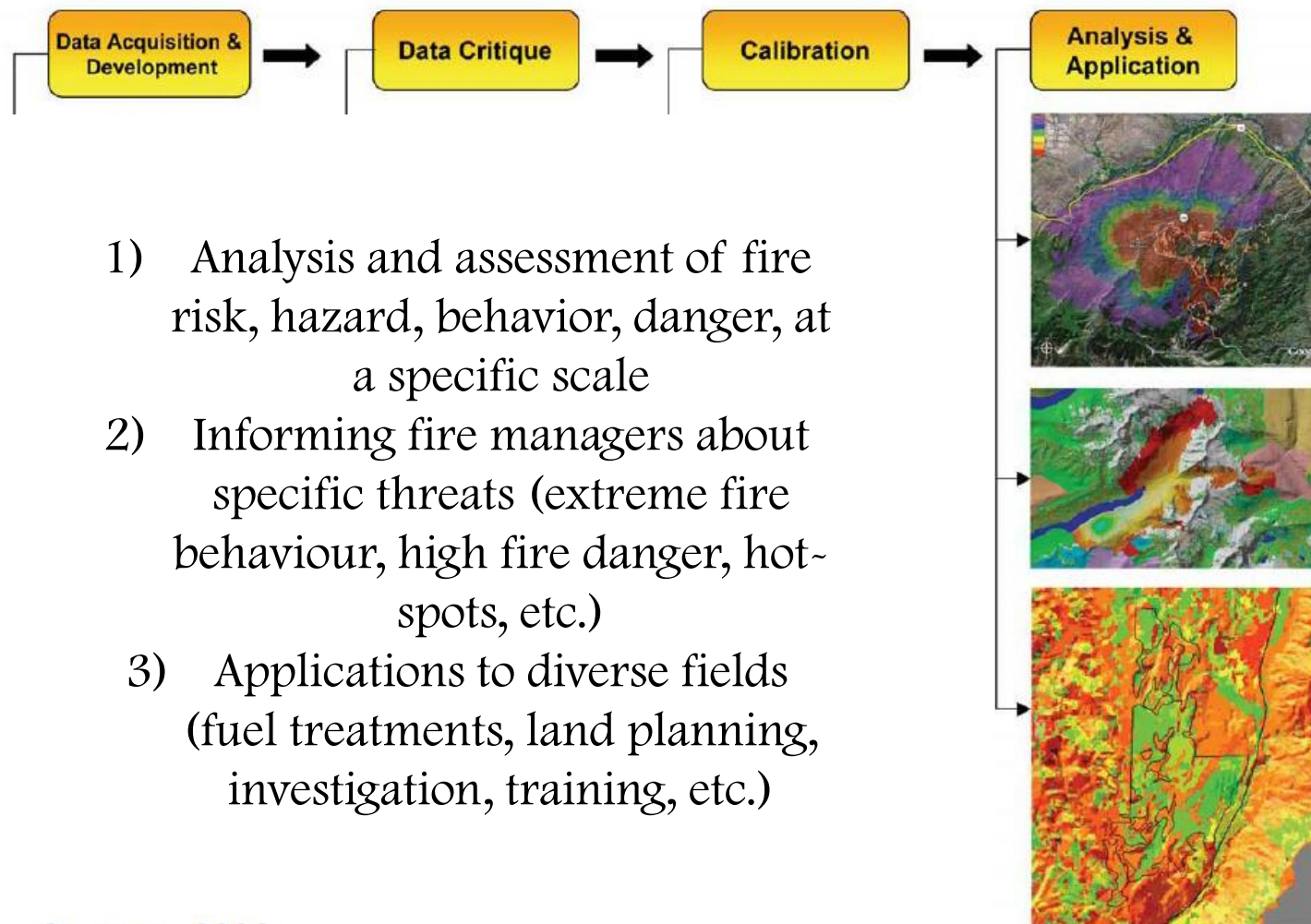

Tools to assess wildfire issues

Main Goal

Main Applications

Fire spread and behaviour modeling



- ~ fire spread and behaviour projections using future scenarios
- ~ assessing fire mitigation strategies (prescribed fires, fuel reduction, etc.)
- ~ quantifying fire exposure and risk
 - ~ identification of hot-spots
 - ~ etc.

Fire danger modeling



- ~ daily/seasonal fire danger forecast
- ~ fire danger projections with future scenarios
 - ~ etc.

Fire Spread and Behavior

How do we characterize fire spread and behavior?

Parts of a Wildfire

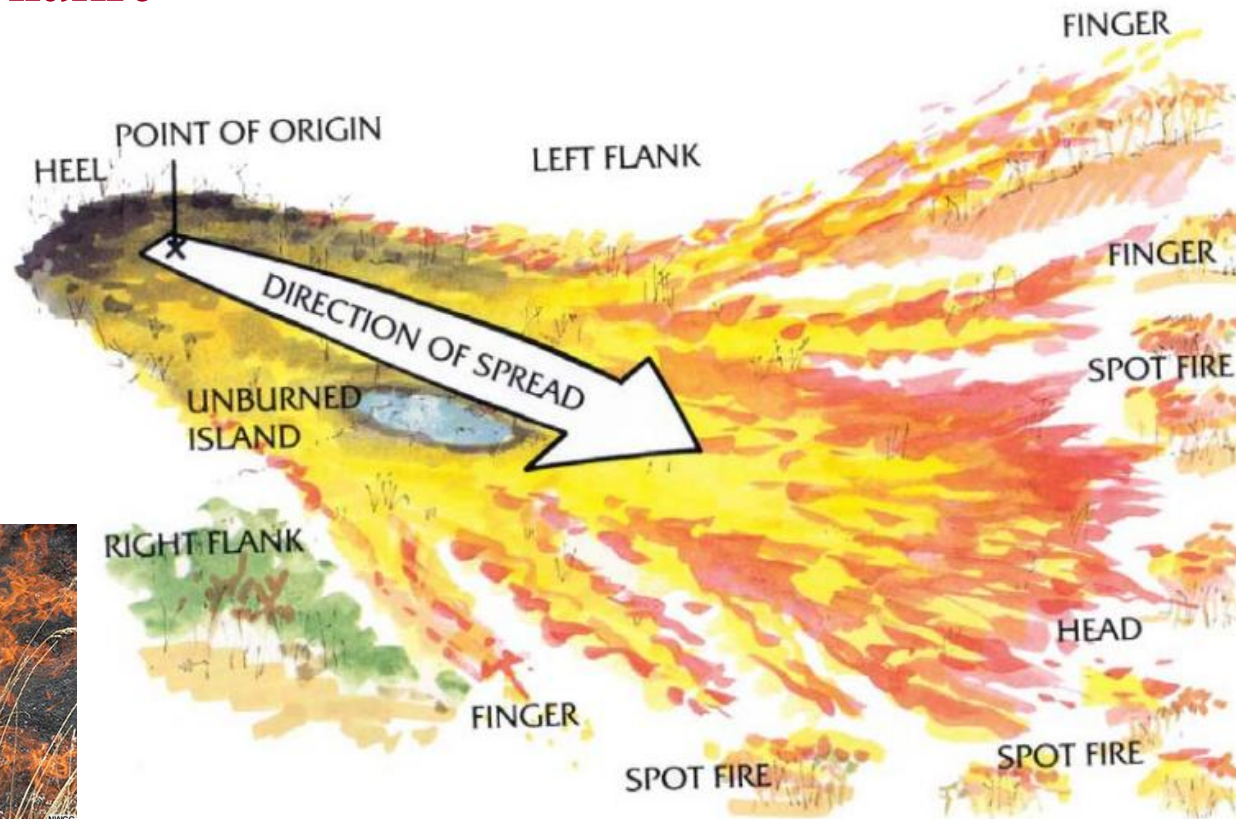

Fire Spread and Behavior

How do we characterize fire spread and behavior?



Fire Shape and Size



Elliptical Fires under Uniform Conditions

- ✓ Fire Size = $f(\text{spread rate, timestep})$
- ✓ Fire Shape (Eccentricity) = $f(\text{wind-slope vector})$
- ✓ Ignition at rear focus of ellipse

Fire Spread and Behavior

How do we characterize fire spread and behavior?

Flame Characteristics

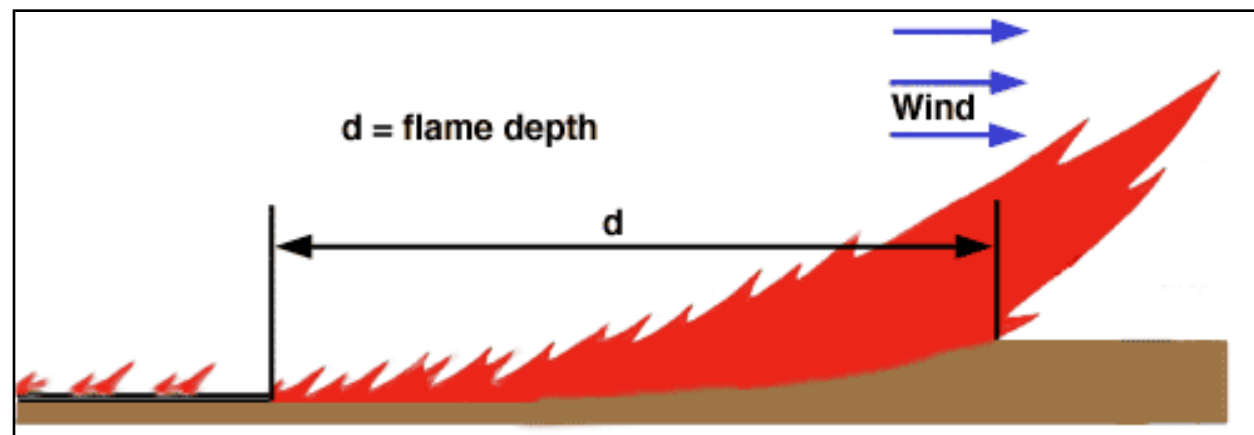
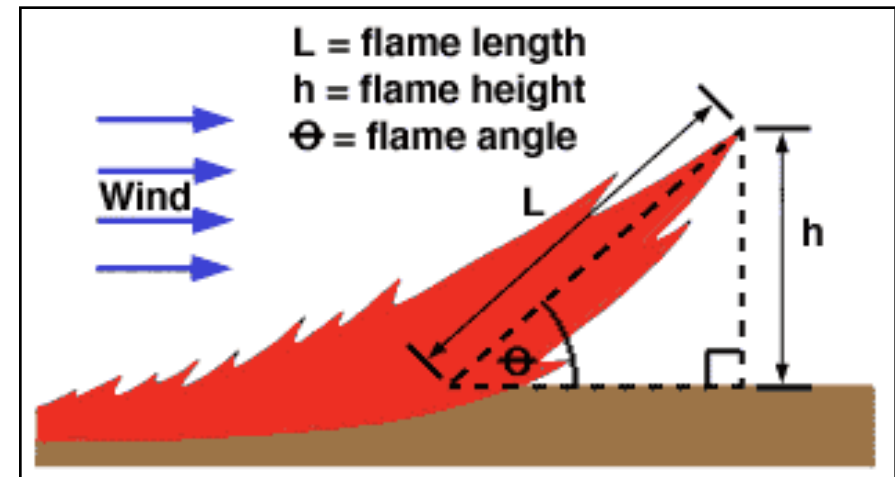

Fire Spread and Behavior

How do we characterize fire spread and behavior?

Behavior Characteristics

- 1) Rate of Spread (m min^{-1})
- 2) Spread Direction ($^{\circ}$)
- 3) Flame Length (m)
- 4) Fireline Intensity (kW m^{-1})
- 5) Heat per Unit Area (kJ m^{-2})
- 6) Crown Fire Occurrence (y/n)

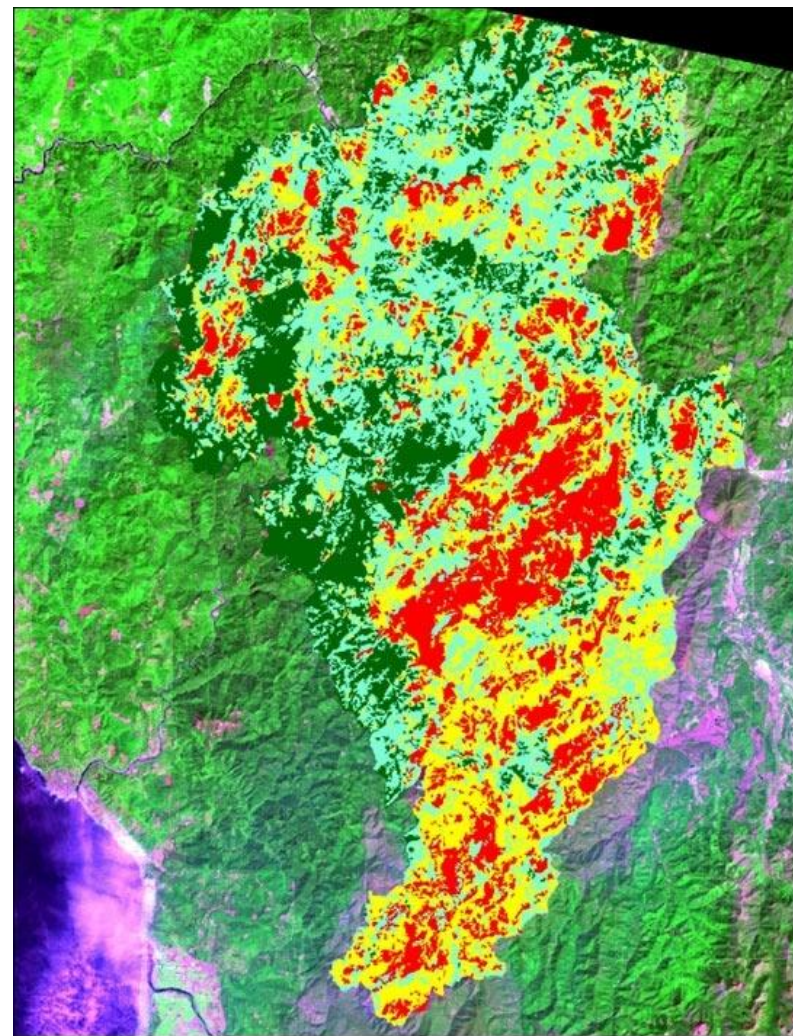

Fire Spread and Behavior Modeling

The **fire spread and behavior models** are software applications which are capable:

- 1) to predict the quantitative features used to describe the spread and behavior of a fire through the landscape (e.g.: ROS; FLI; etc.)
- 2) to predict the shape and/or the spatial extent of a wildland fire
- 3) to inform fire managers and researchers by considering a wide range of environmental and management conditions and scenarios (historic, real time, hypothetical, future)

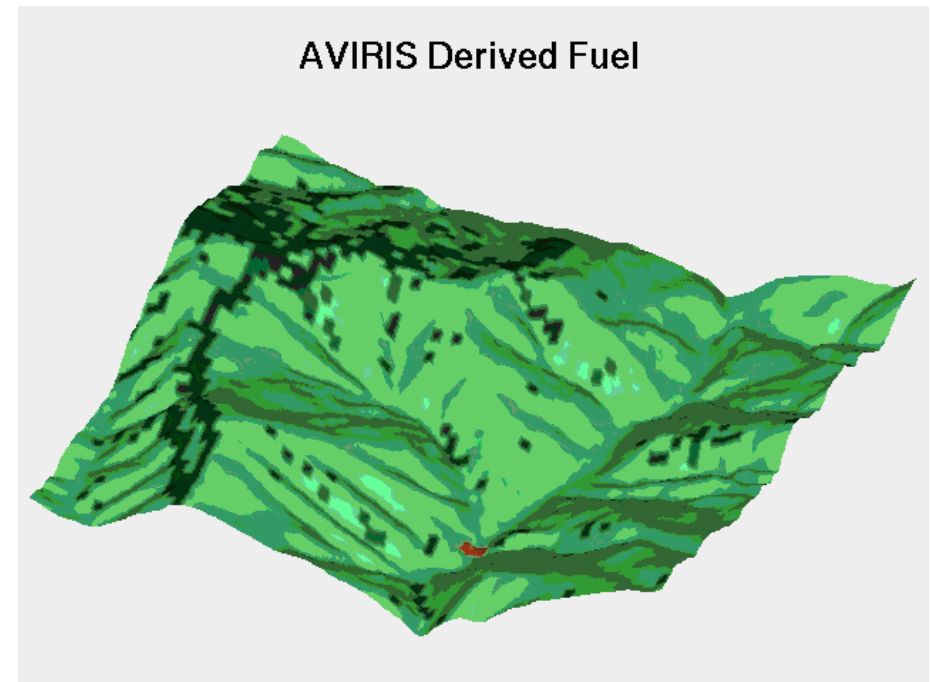

Fire Spread and Behavior Modeling

A fire simulator is composed by

A) Fire Simulation Technique



It represents the technique by which the parameters describing both fire spread and behaviour are compounded at landscape-level

B) Fire Prediction Model



It is the core of the simulator, and simulates the fire propagation and behavior by considering a set of environmental conditions as inputs

Fire Spread and Behavior Modeling

A) Fire Simulation Technique

It represents the technique by which the parameters describing both fire spread and behavior are compounded at landscape-level



Landscape composed by a given number of cells

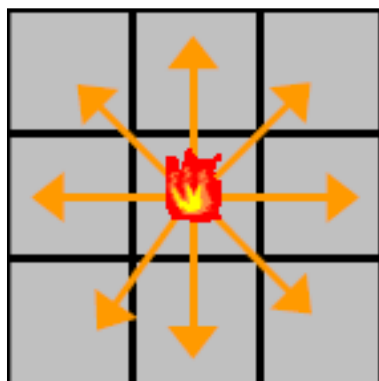

Bond Percolation and Cellular Automata (Cellular Models)

Landscape as a continuum medium

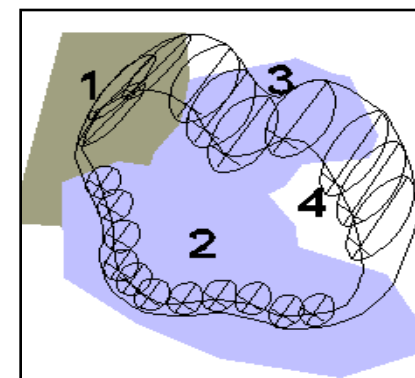

Elliptical Wave Propagation and Minimum Travel Time

Fire Spread and Behavior Modeling

B) Fire Prediction Model

It is composed by a set of equations the solutions of which give predicted fire behavior and spread data (rate of spread, fireline intensity, etc)

The outputs are strongly dependent on the environmental conditions (winds, fuel load, fuel moisture, etc)

Two main classifications of Fire Prediction Models

Fire Spread and Behavior Modeling

B) Fire Prediction Model

i) Physical System Modelling

Surface Fires

The most investigated and diffuse fire models



Fire Spread and Behavior Modeling

B) Fire Prediction Model

i) Physical System Modelling

Surface Fires



Fire Spread and Behavior Modeling

B) Fire Prediction Model

i) Physical System Modelling

Crown Fires



Very difficult to be studied

Fire Spread and Behavior Modeling

B) Fire Prediction Model

i) Physical System Modelling

Crown Fires

Stages of Crown Fire

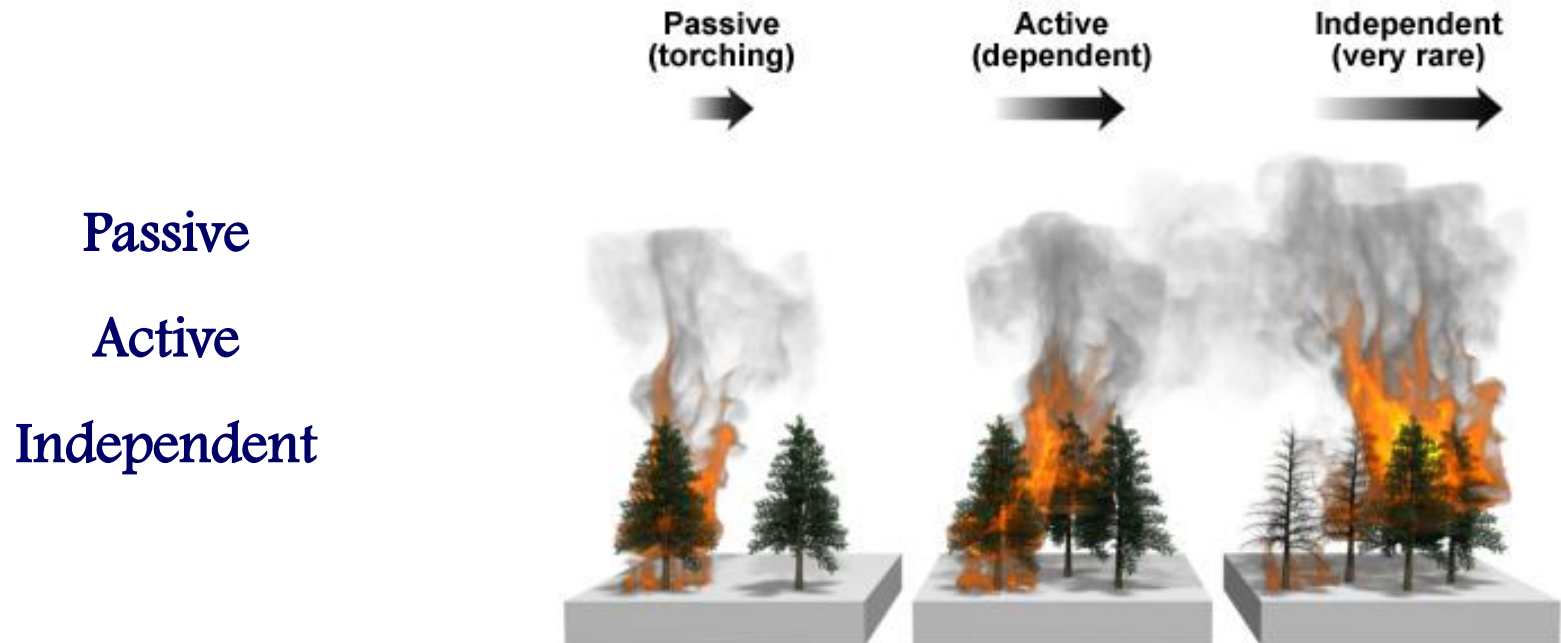

Fire Spread and Behavior Modeling

B) Fire Prediction Model

i) Physical System Modelling

Ground Fires



Fire Spread and Behavior Modeling

B) Fire Prediction Model

i) Physical System Modelling

Spot Fires



Very very difficult to be studied!

Fire Spread and Behavior Modeling

B) Fire Prediction Model

ii) Heat Transfer Modelling

Physical Models (Theoretical)

Empirical Models (Statistical)

Semi-Empirical Models (Semi-Physical)



Rothermel's Equation (1972)

(Pastor et al., 2003)

Fire Spread and Behavior Modeling

Rothermel's Equation (1972)

$$R = \frac{I_r \pi (1 + \phi_w + \phi_s)}{\rho_b \varepsilon Q_{ig}}$$

R = rate of spread (in m min^{-1}), the forward rate of propagation of the surface fire front, in stationary conditions

I_r = reaction intensity, the energy release rate per unit area of flame front;

π = propagating flux ratio, the fraction of energy released responsible for neighboring fuel heating and ignition;

Φ_w, Φ_s = adimensional factors linked to wind and slope;

ρ_b = bulk density, the dry mass of fuel per unit volume;

ε = effective heating number, the ratio between the bulk density and the mass of fuel involved in the ignition process;

Q_{ig} = heat of pre-ignition, the heat required to bring the unit weight of fuel to ignition.

Fire Spread and Behavior Modeling

Rothermel's Equation (1972)

$$R = \frac{I_r \pi (1 + \phi_w + \phi_s)}{\rho_b \epsilon Q_{ig}} = \frac{I_r \pi}{\rho_b \epsilon Q_{ig}} + \frac{I_r \pi \phi_w}{\rho_b \epsilon Q_{ig}} + \frac{I_r \pi \phi_s}{\rho_b \epsilon Q_{ig}}$$

Fire rate of spread

Rate of spread fraction mainly determined by fuelbed and fuel particles characteristics

Rate of spread fraction mainly linked with the wind speed

Rate of spread fraction mainly determined by the slope

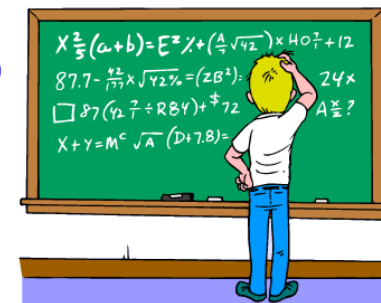
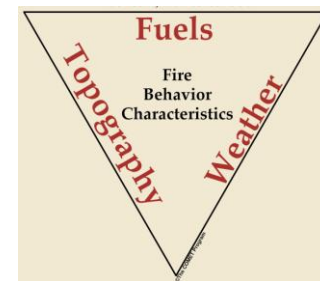

Fire Spread and Behavior Modeling

Rothermel's Equation (1972)

$$R = \frac{I_r \pi (1 + \phi_w + \phi_s)}{\rho_b \varepsilon Q_{ig}}$$

Total heat released by the combustion process in a defined system (landscape with given environmental conditions)

Heat that the system is able to absorb (strongly related to fuel characteristics)

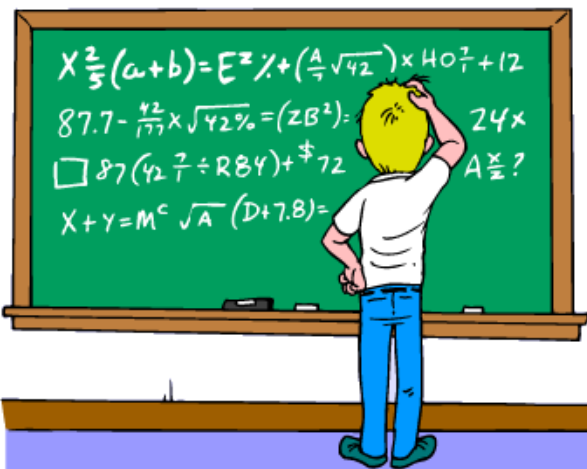

Fire Spread and Behavior Modeling

<i>NAME</i>	<i>COUNTRY</i>	<i>AUTHORS</i>	<i>MAIN CHARACTERISTICS</i>	
BURN	United States	Veach et al. (1994)	SFM Rothermel	Cellular simulation technique (cellular automaton)
CARDIN	Spain	Martinez Millán et al. (1991)	SFM Rothermel	Cellular simulation technique
DYNAFIRE	United States	Kalabokidis et al. (1991)	SFM Rothermel	Cellular simulation technique (cellular automaton)
EMBYR	United States	Hargrove et al. (2000)	SFM Hargrove et al.	SM Albini; Cellular simulation technique (bond percolation)
FARSITE	United States	Finney (1994)	SFM Rothermel CFIM Finney	SM Albini; Wave simulation technique; CFSM Scott and Reinhardt
FIREGIS	Portugal	Almeida et al. (1997)	SFM Rothermel	Cellular simulation technique (cellular automaton)
FIREMAP	United States	Ball and Guertin (1992)	SFM Rothermel	Cellular simulation technique (cellular automaton)
FIRESTATION	Portugal	Lopes et al. (1998)	SFM Rothermel	Cellular simulation technique
FLAMMAP	United States	Finney (2003)	SFM Rothermel CFIM Finney	Wave simulation technique; CFSM Scott and Reinhardt
GEOFOGO	Portugal	Vasconcelos et al. (1998)	SFM Rothermel	Cellular simulation technique
INTEGRATED INFLAME SOFTWARE SYSTEM	European Union	Viegas (2000)	Viegas et al.; Marguerit and Guillaume	Cellular simulation technique
MEFISTO-AIOLOS-F	Greece	Lymberopoulos et al. (1996)	SFM Croba et al.	Cellular simulation technique
PFAS	Canada	Anderson (2002)	SFM Forestry Canada Fire Danger Group	CFSM Forestry Canada Fire Danger Group; Cellular simulation technique
PROMETHEUS	Canada	Canadian Wildland Fire Growth Model Project Team (1999)	SFM Forestry Canada Fire Danger Group	CFSM Forestry Canada Fire Danger Group; Wave simulation technique
PYROCARD	New Zealand	Perry et al. (1999)	SFM Rothermel	Cellular simulation technique
SIROFIRE	Australia	Coleman and Sullivan (1995)	SFM McArthur	Wave simulation technique
SPARKS	Switzerland	Schöning (1996)	SFM Rothermel	Cellular simulation technique
SPREAD	Portugal	Mendes-Lopes et al. (2000)	SFM Rothermel	Cellular autom. simulation technique
WILDFIRE	Canada	Wallace (1993)	SFM Forestry Canada Fire Danger Group	CFSM Forestry Canada Fire Danger Group

SFM = surface fire model; CFIM = crown fire ignition model; CFSM = crown fire spread model; SM = spotting model

Fire Spread and Behavior Modeling

Fire Spread and Behavior Models: Workflow

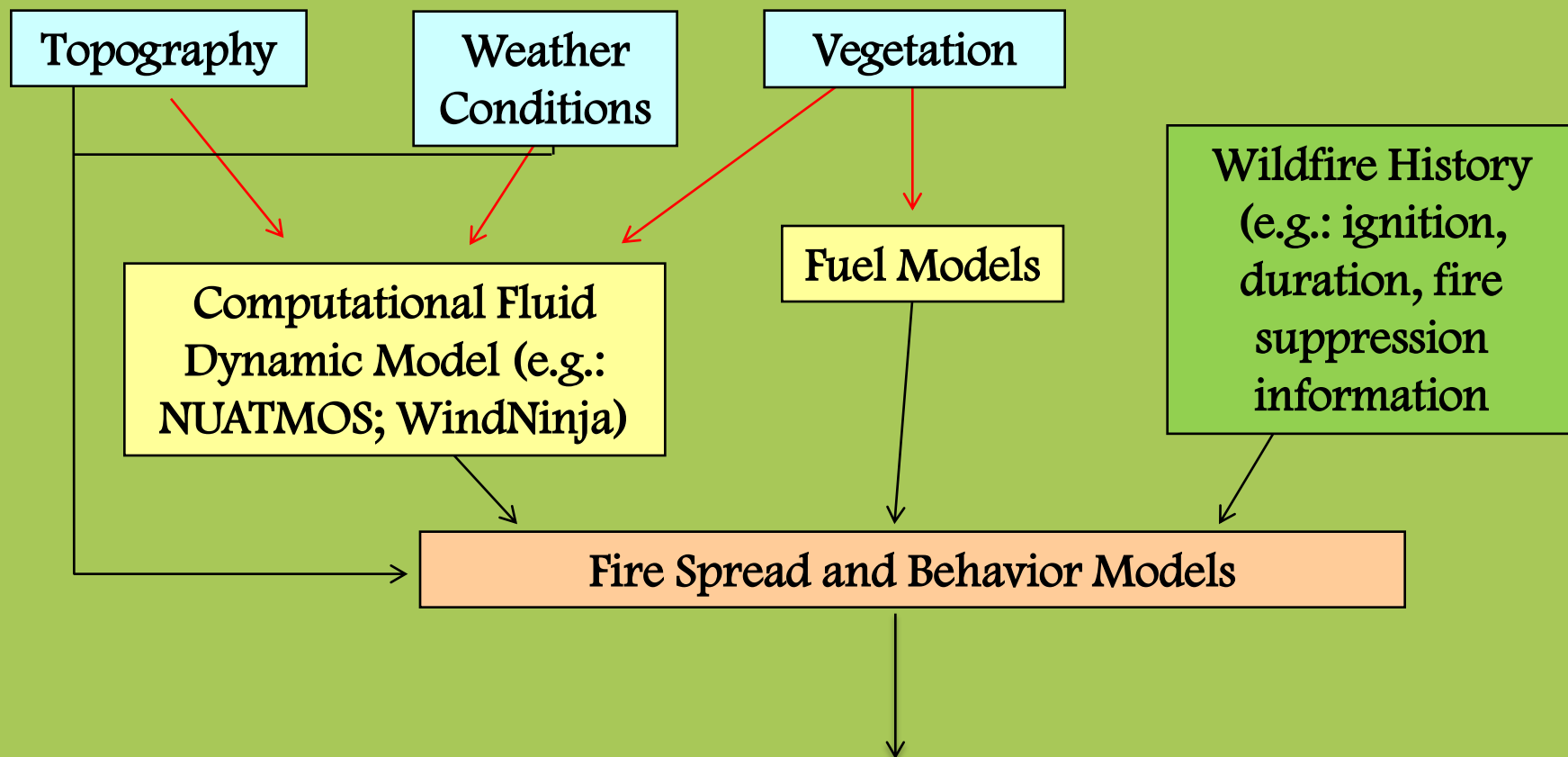

Fire Perimeters; Fire Rate of Spread (ROS); Fireline Intensity (FLI); Flame Length (FL); Burn Probability (BP); Spread Direction (SDR); etc

Fire Spread and Behavior Modeling

Fire Spread Modelling Issues related to the Input Data

Spatial and temporal variability of weather conditions (particularly wind speed and direction)



Topography does not change in time but only in space, and represents an “easy” input

- a) Spatio-temporal variability and heterogeneity of vegetation (species, age, moisture, height, canopy cover, etc.)
- b) Several information to describe the fuel characteristics (load, moisture, moisture of extinction, SAV ratio, heat content, etc.)
 - c) Need to “create” reference (custom) fuel models
- d) Few studies on Mediterranean fuel types (e.g. Mediterranean maquis)

Fire Spread and Behavior Modeling



FARSITE (Finney, 1998)

Based on the semi-empirical fire model of Rothermel (1972) for surface fire spread

The spatial growth of the fire perimeter is simulated by the elliptical wave propagation technique

Surface fire modelling

Crown fire modelling

Spot fires modelling

Post frontal combustion

Fire acceleration

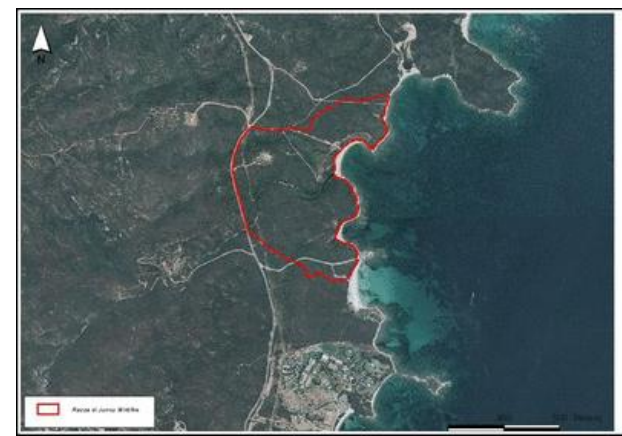

Fire Spread and Behavior Modeling

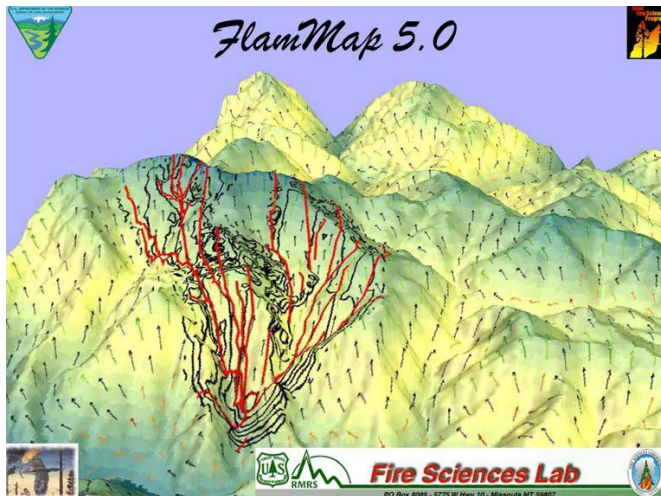

FlamMap (Finney 2006)

Based on the semi-empirical fire model of Rothermel (1972) for surface fire spread

A fire behavior mapping and analysis program that computes potential fire behavior characteristics (such as spread rate, flame length, and fireline intensity) over an entire landscape using constant weather and fuel moisture conditions for an instant in time

a) Basic FlamMap

b) MTT FlamMap

Fire Spread and Behavior Modeling

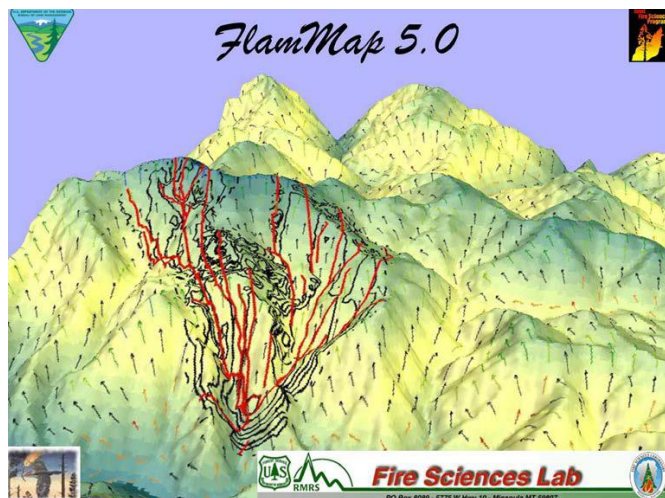

a) Basic FlamMap

FlamMap (Finney 2006)

b) MTT FlamMap

It is not a fire growth simulation model. It provides fire behavior characteristics for every cell, as if the entire landscape was burning all at the same time.

(FARSITE provides fire behavior characteristics within the simulated fire perimeter)

It is spatial and provides fire growth across the landscape for short periods of time for a single set of wind and fuel moisture conditions. It also calculates fire flow paths

New command-line versions of MTT FlamMap (Randig)

Fire Spread and Behavior Modeling

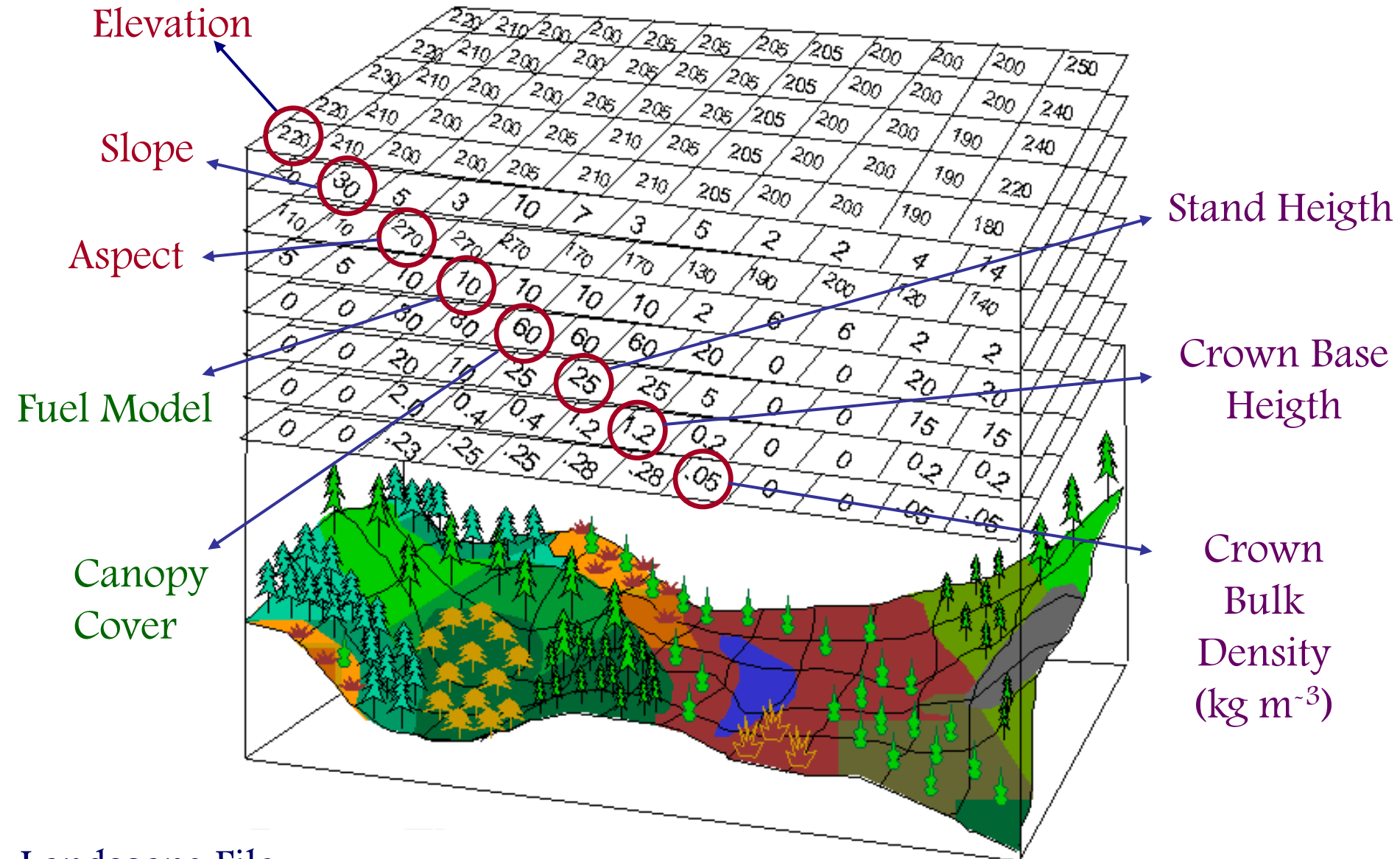

Fire Spread and Behavior Modeling

Weather Conditions \longrightarrow Dynamic

Input Data

Wind Speed (km/h) and Direction ($0^\circ - 360^\circ$)

Minimum and Maximum Temperatures ($^\circ\text{C}$)

Minimum and Maximum Relative Humidity (%)

Cloud Cover (%)

Rain (mm)

Raster Format (ascii files) or constant values for each weather station

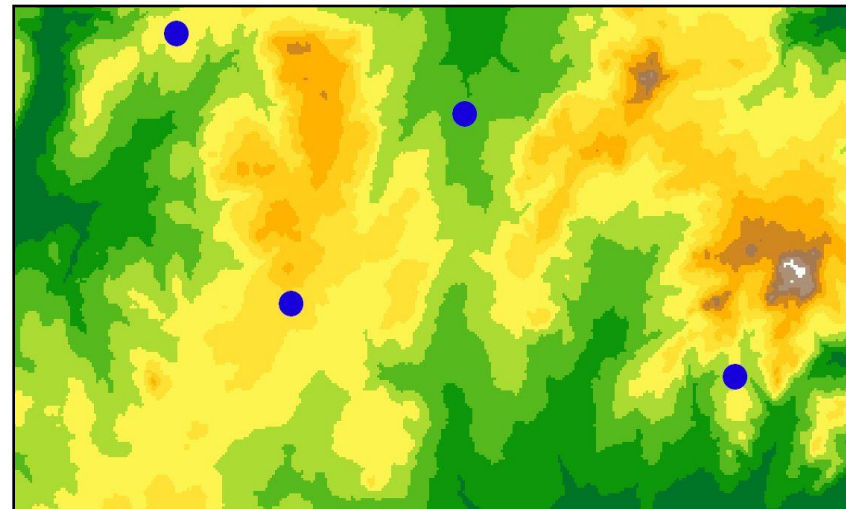

Fire Spread and Behavior Modeling

Fuels

—————> Dynamic /Static

Input Data

- ~ Fuel Load ($t\ ha^{-1}$)
- ~ SAV Ratios (cm^{-1})
- ~ Fuelbed Depth (m)
- ~ Moisture of Extinction (% DW)
- ~ Heat Content ($kJ\ kg^{-1}$)
- ~ Canopy Cover (%)
- ~ Moisture (% DW)

Raster Format (ascii files)

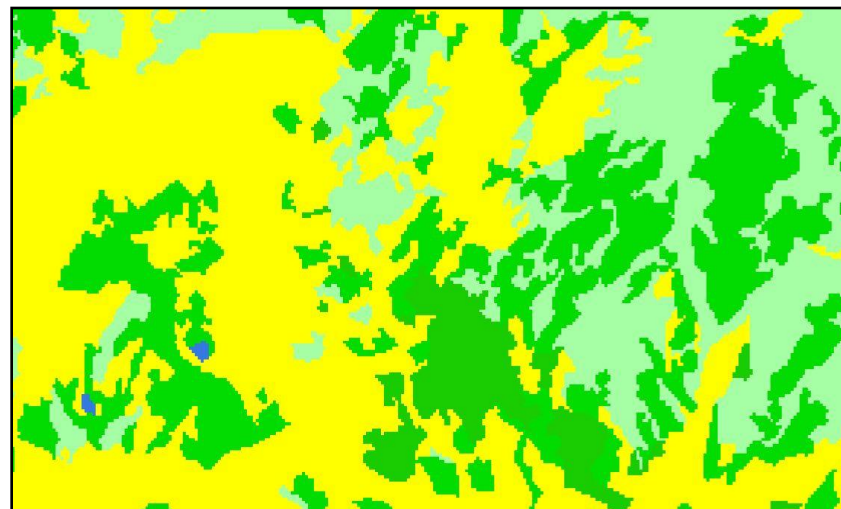

Fire Spread and Behavior Modeling

Fuels

—————> Dynamic /Static

Input Data

Timelag Classes

0÷0.6 cm (1hr)

0.6÷2.5 cm (10hr)

2.5÷7.6 cm (100hr)

> 7.6 cm (1000 hr)

Fuel Load, SAV Ratio



Fire Spread and Behavior Modeling

Fire data

—————> Dynamic /Static

Input Data

Ignition point

Aerial and terrestrial attacks

Barrier creation

Other fire information or observations



Raster or Vector Format (ascii files)

Fire Spread and Behavior Modeling

Need to calibrate and validate the fire spread models...

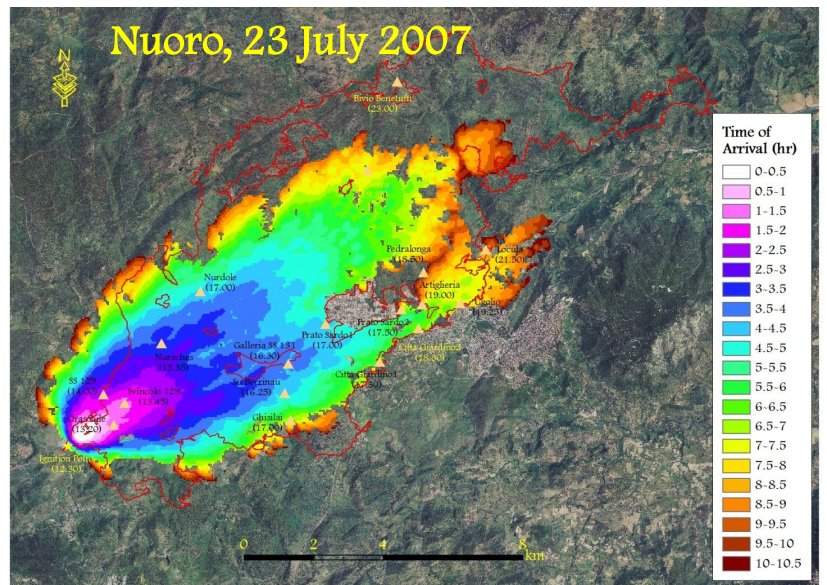
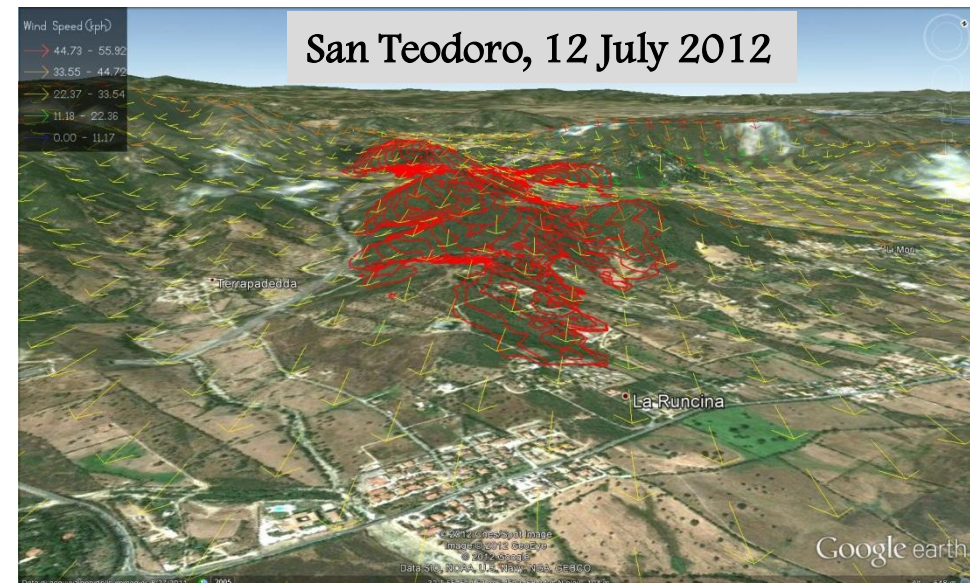
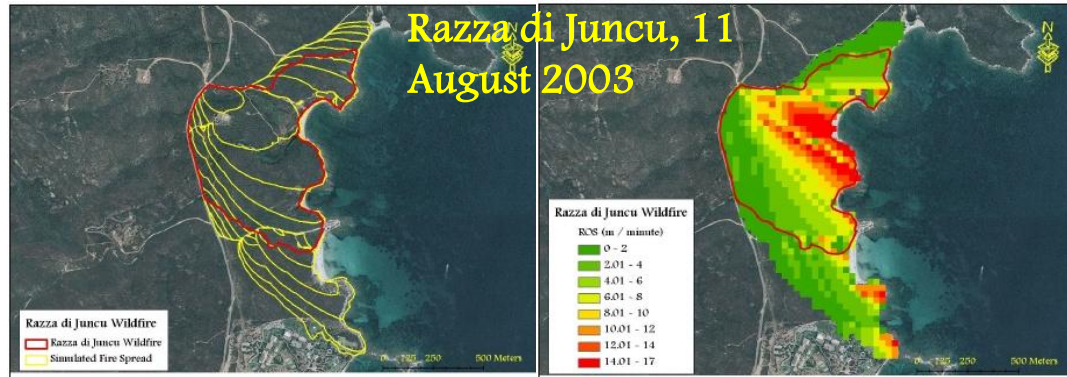
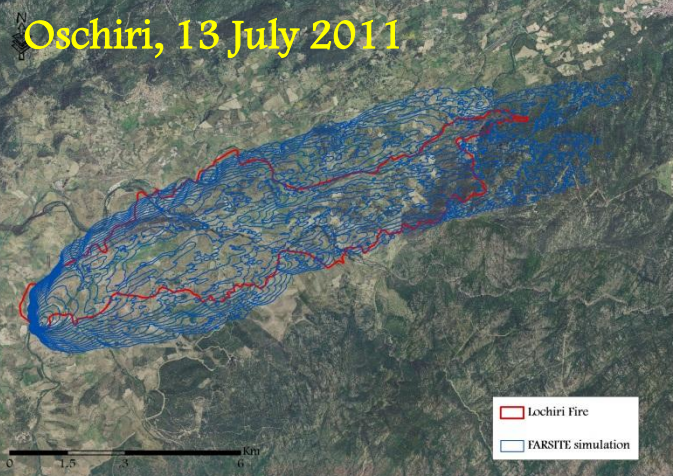

(Salis et al.; Arca et al.; Alcasena et al.; Jahdi et al.)

Fire Spread and Behavior Modeling

Nuoro
wildfire
23 July
2007

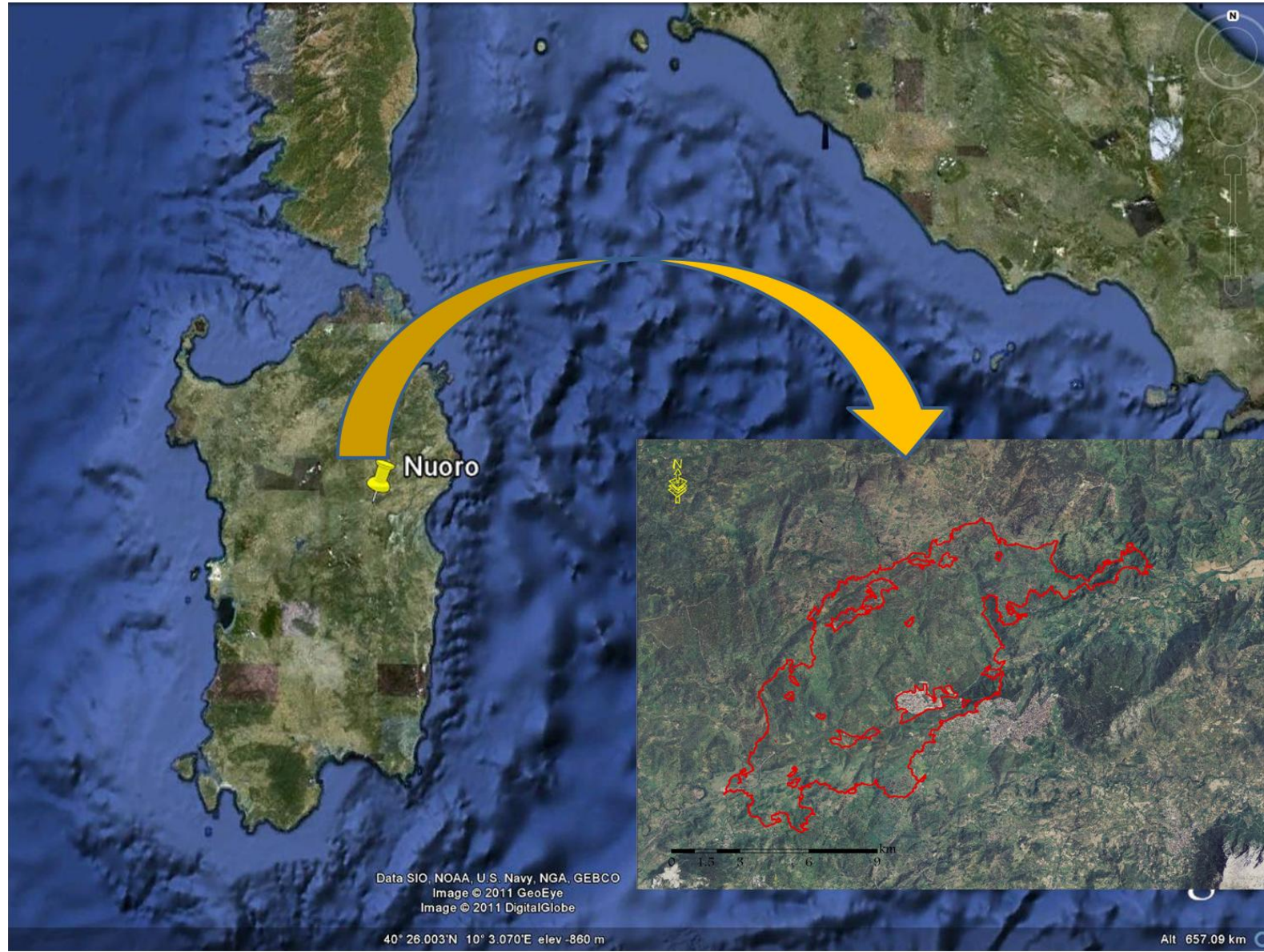

Fire Spread and Behavior Modeling

About 24 hours of propagation

9,000 ha of burned areas

About 7,400 ha in 10 hours

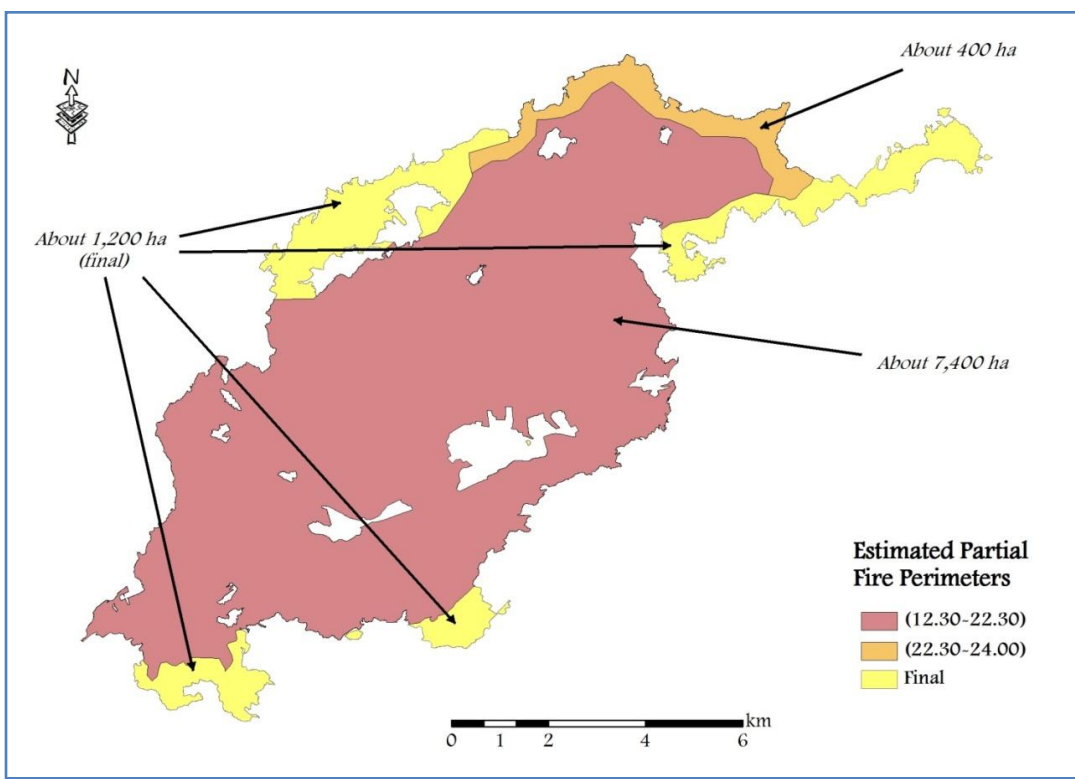
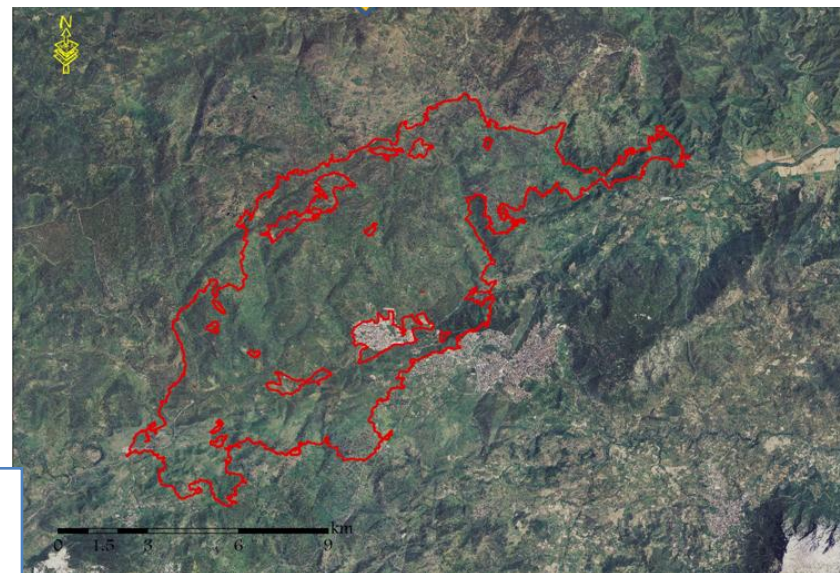

Several damages to values and civil protection problems

Manca, 2011

Fire Spread and Behavior Modeling



Courtesy of Sardinia
Forest Service

Fire Spread and Behavior Modeling



Courtesy of
Sardinia Forest
Service

Fire Spread and Behavior Modeling

The vegetation is characterised by a mix of pastures, cork oak forests and Mediterranean maquis

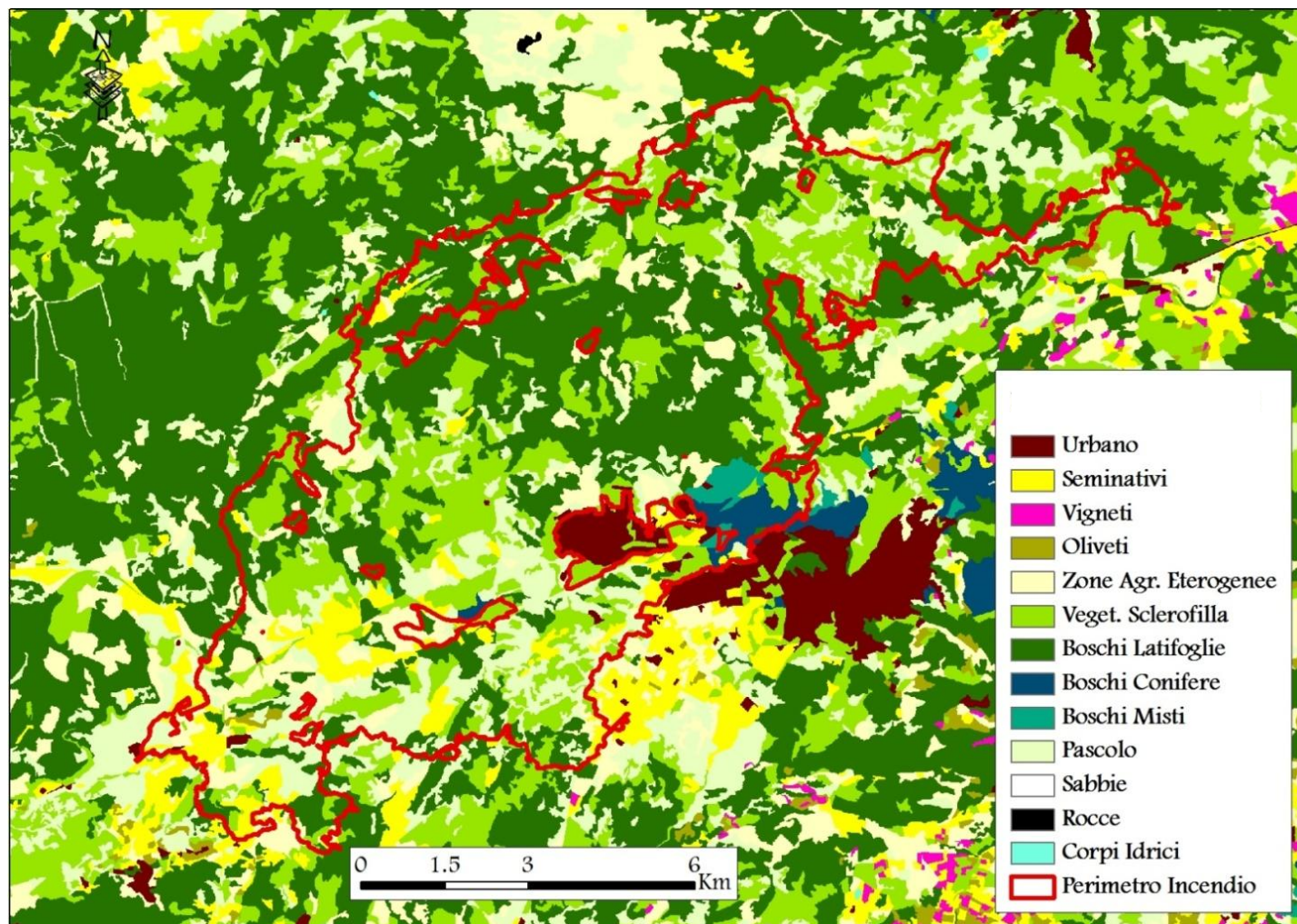

Fire Spread and Behavior Modeling

Extreme weather conditions with very high maximum temperatures ($>40^{\circ}\text{C}$), low relative humidity ($<20\%$), strong winds (35 kmh) from SW

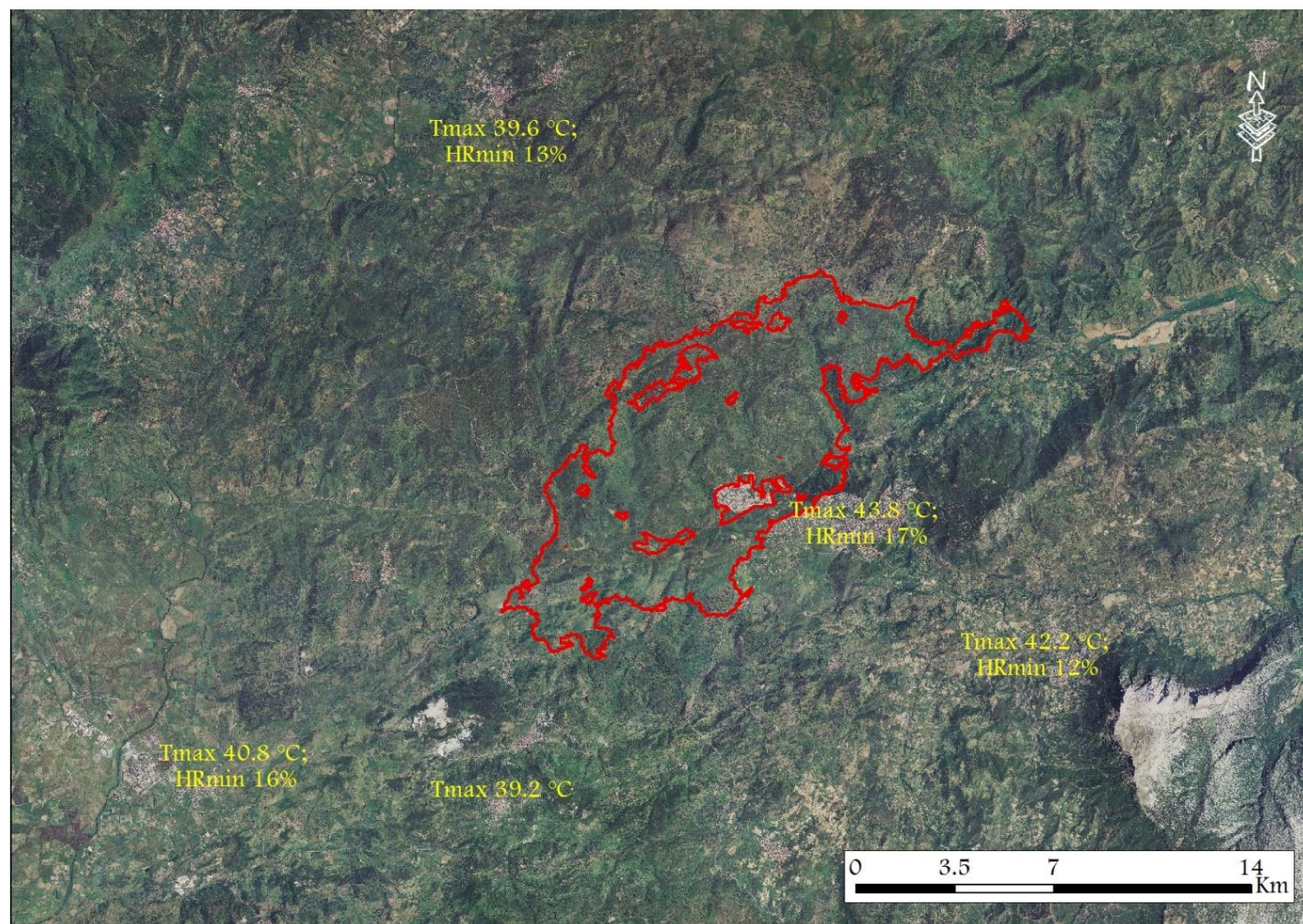

Fire Spread and Behavior Modeling

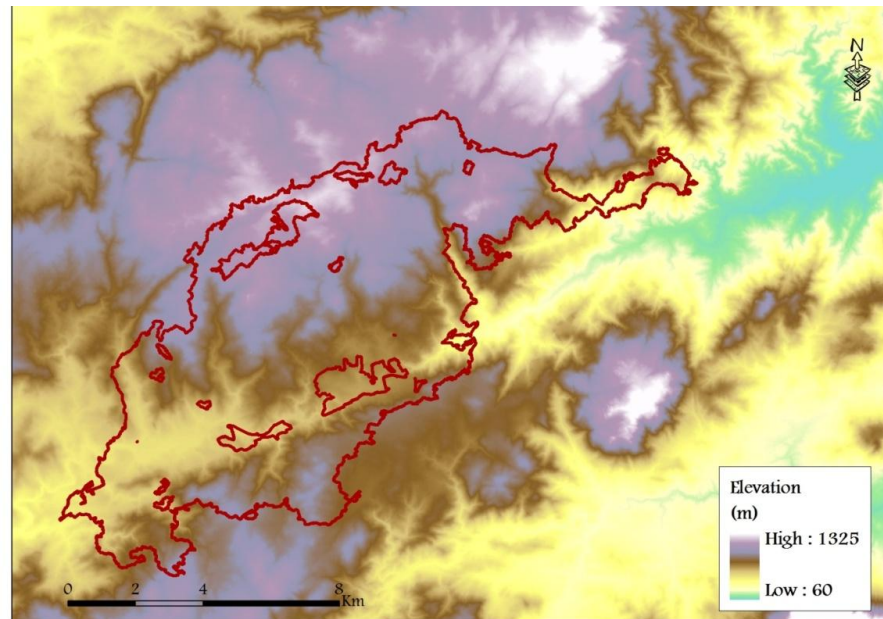

Elevation map

Wind field map (WindNinja)
(2.30 pm)

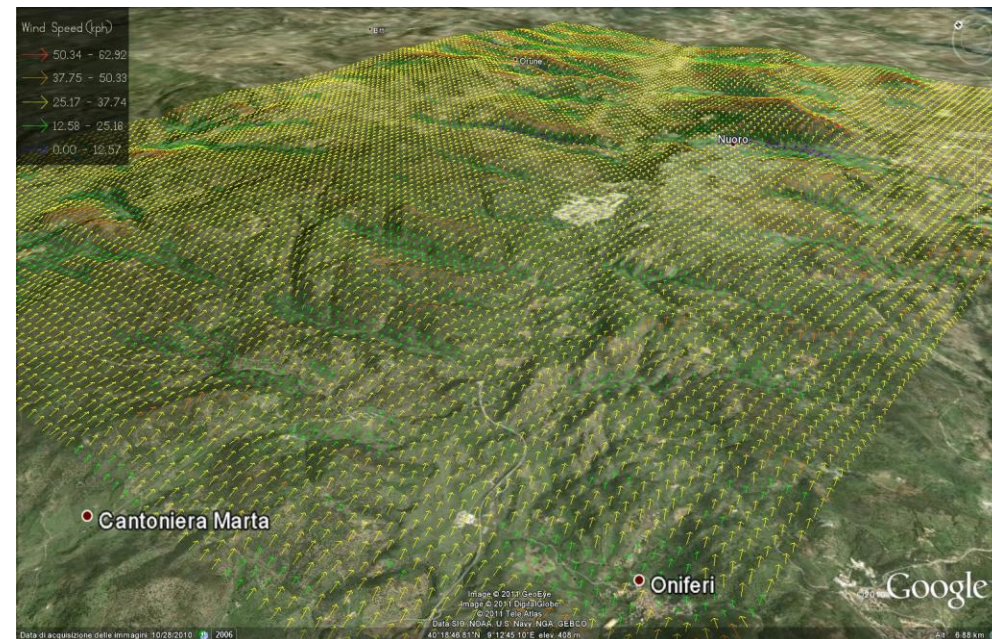

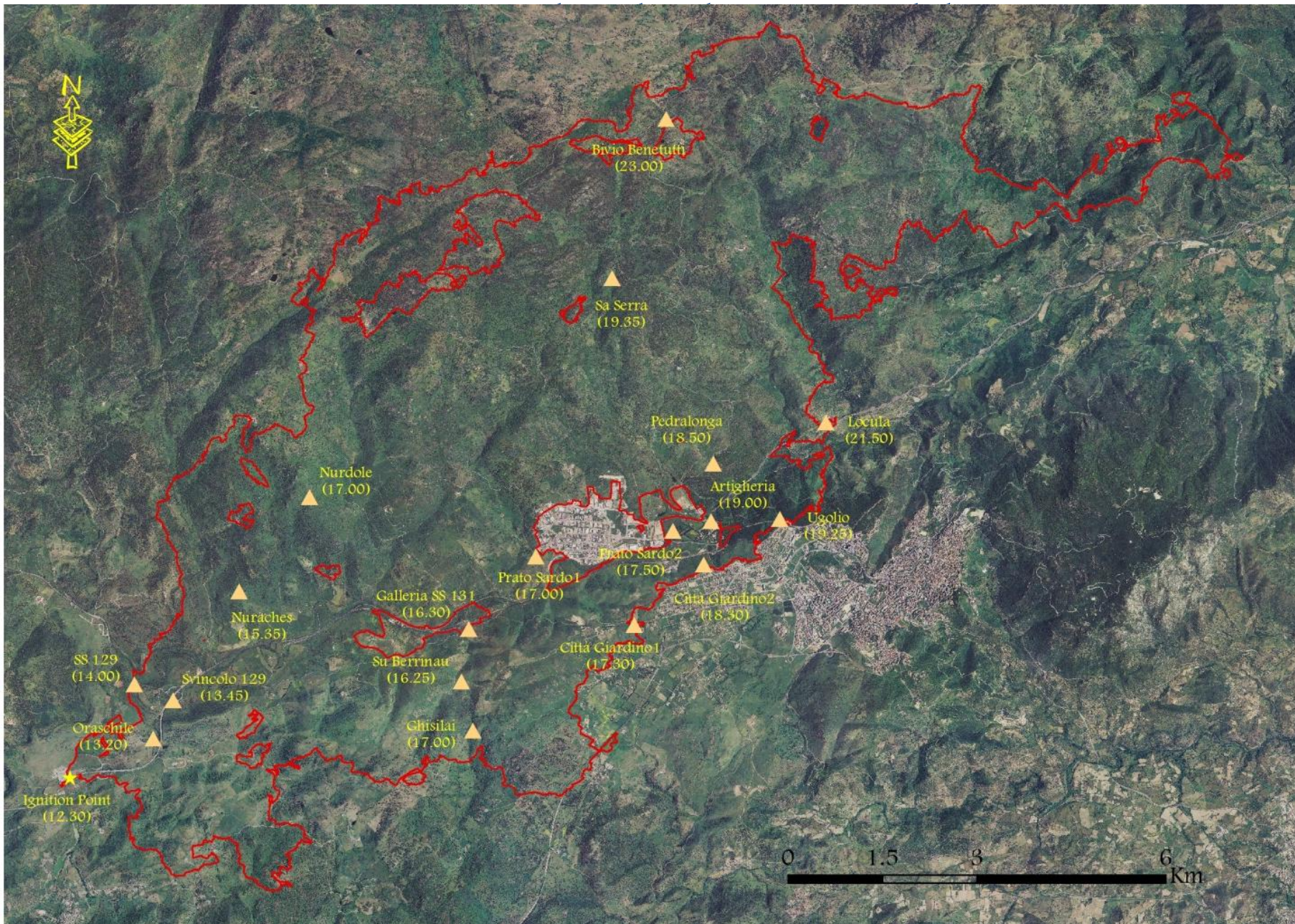

Fire Spread and Behavior Modeling

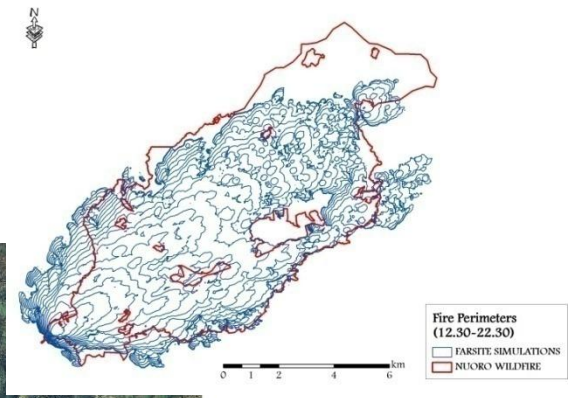
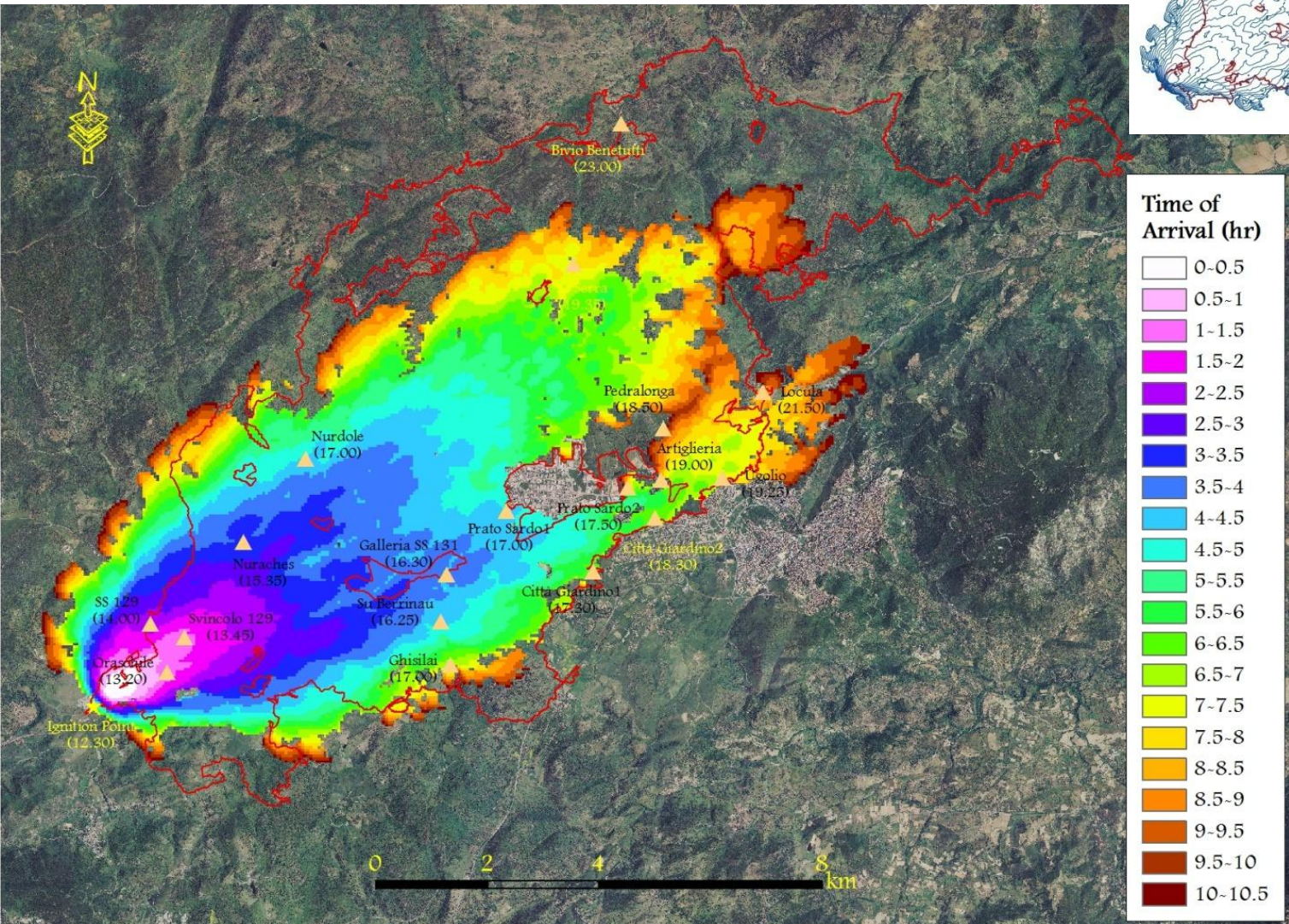

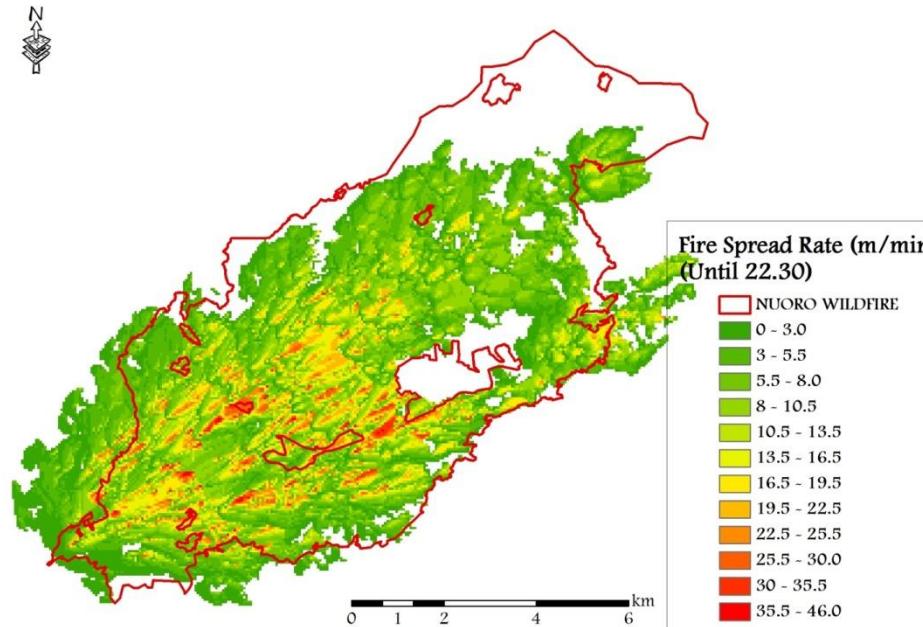
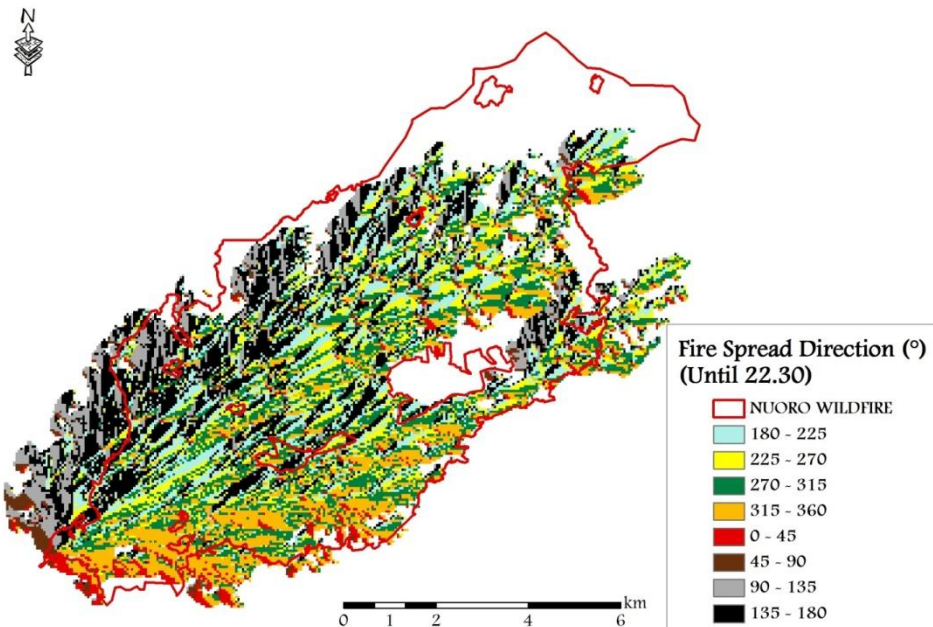
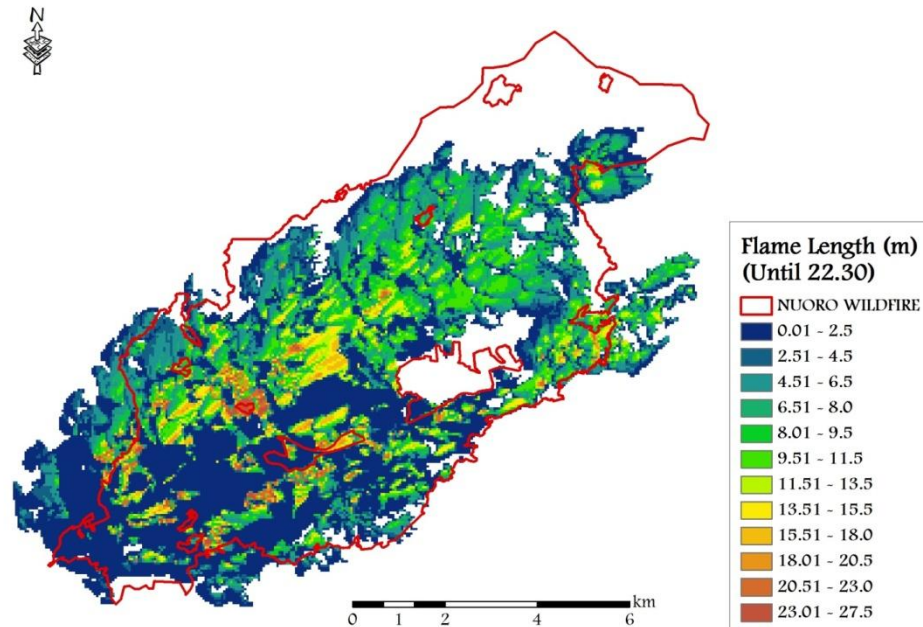
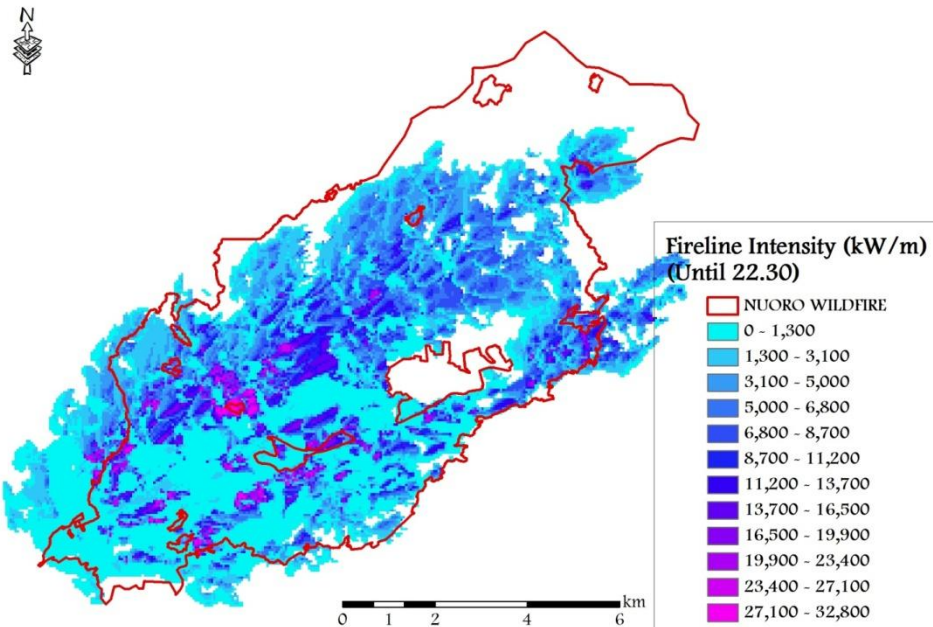

Fire Spread and Behavior Modeling

Fire simulation accuracy (Sorensen and Kappa coefficients)

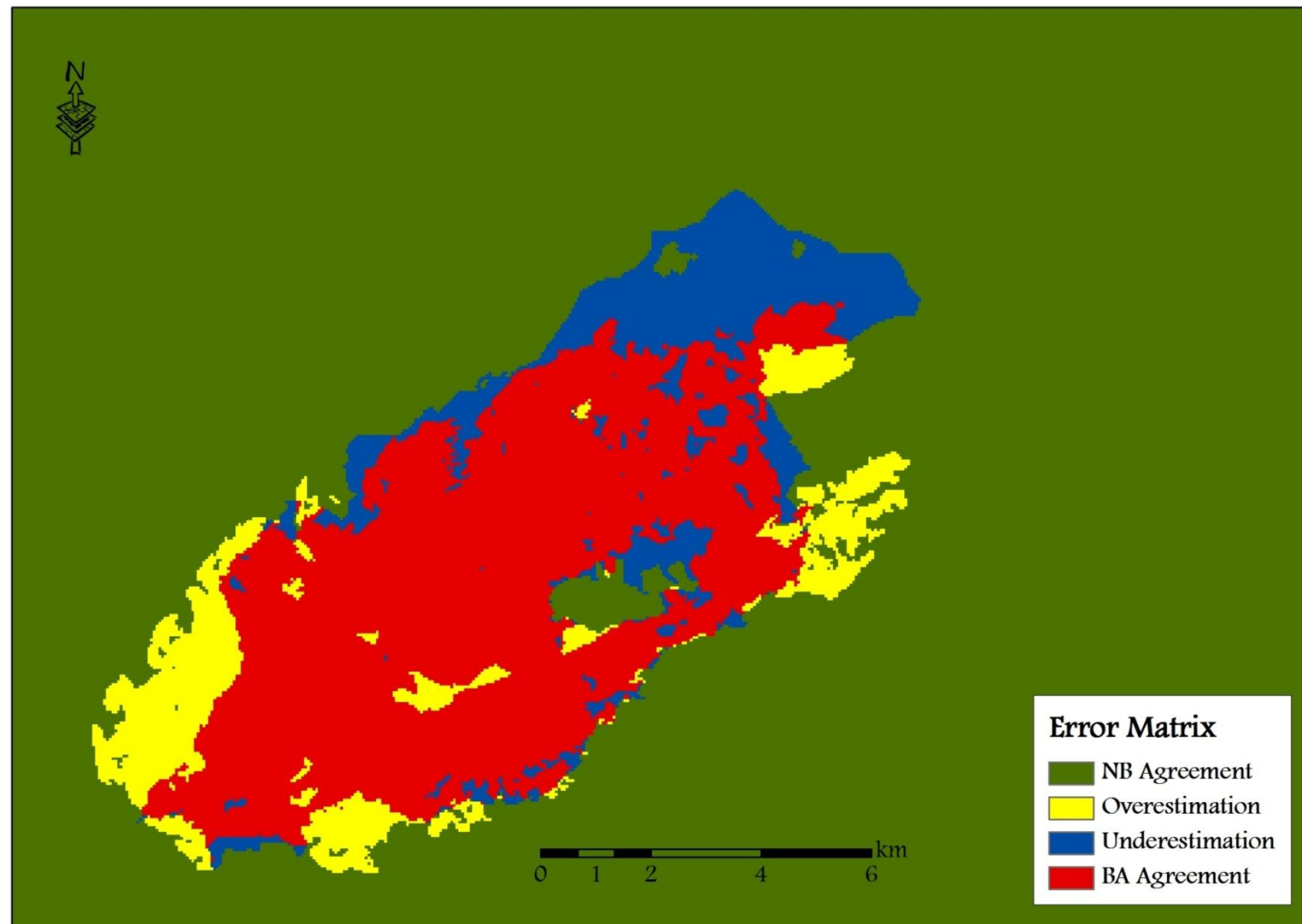

Fire Spread and Behavior Modeling

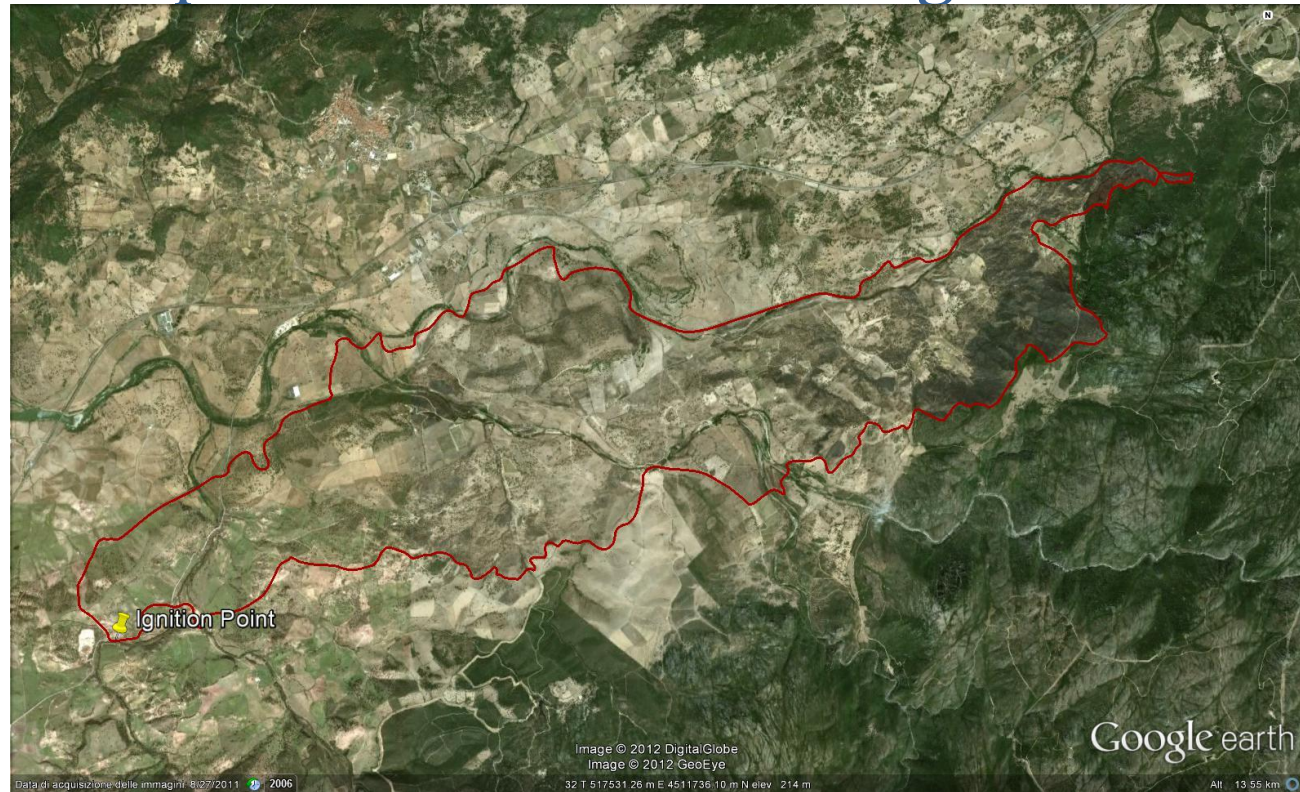

Site: Lochiri
Village: Oschiri,
Sardinia

Burned Area:
2500 ha

Fire Start: 13/07/2011, 12.45 a.m. LST

Fire End: 13/07/2011, 7.15 p.m. LST

Main Vegetation: Open Pastures, Wooded Pastures, Orchards, Quercus woods, Pinus stands, Grasslands

Wind: SSW, 35 kmh^{-1} ; Max Temp.: $40 \text{ }^\circ\text{C}$

Fire Spread and Behavior Modeling

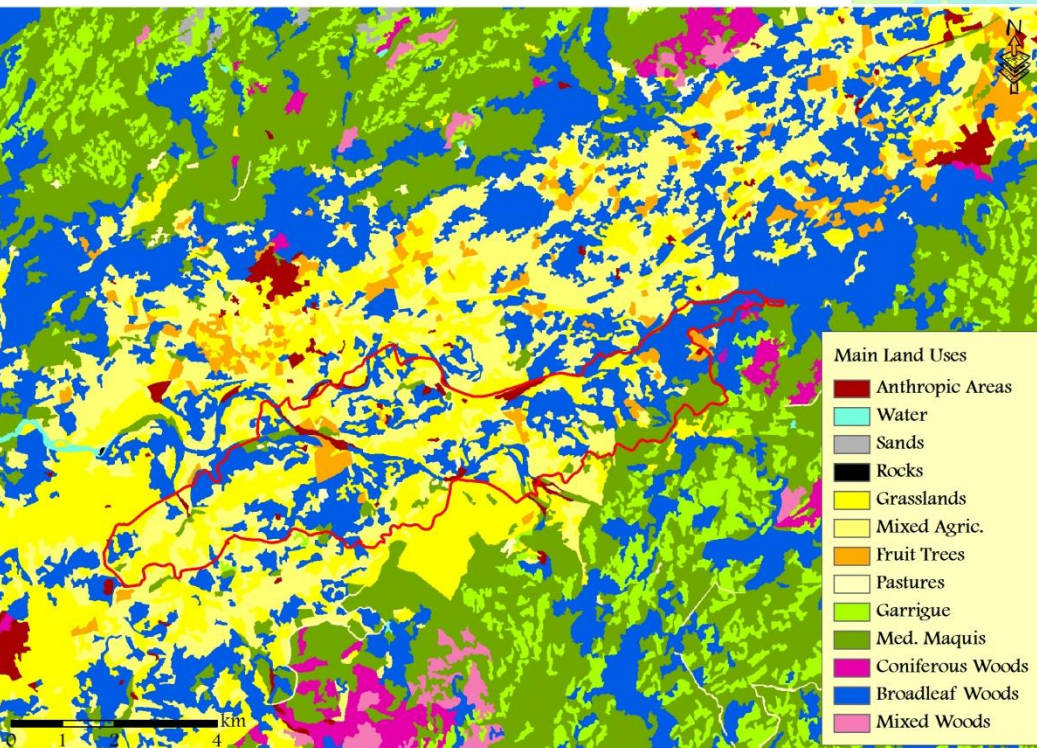
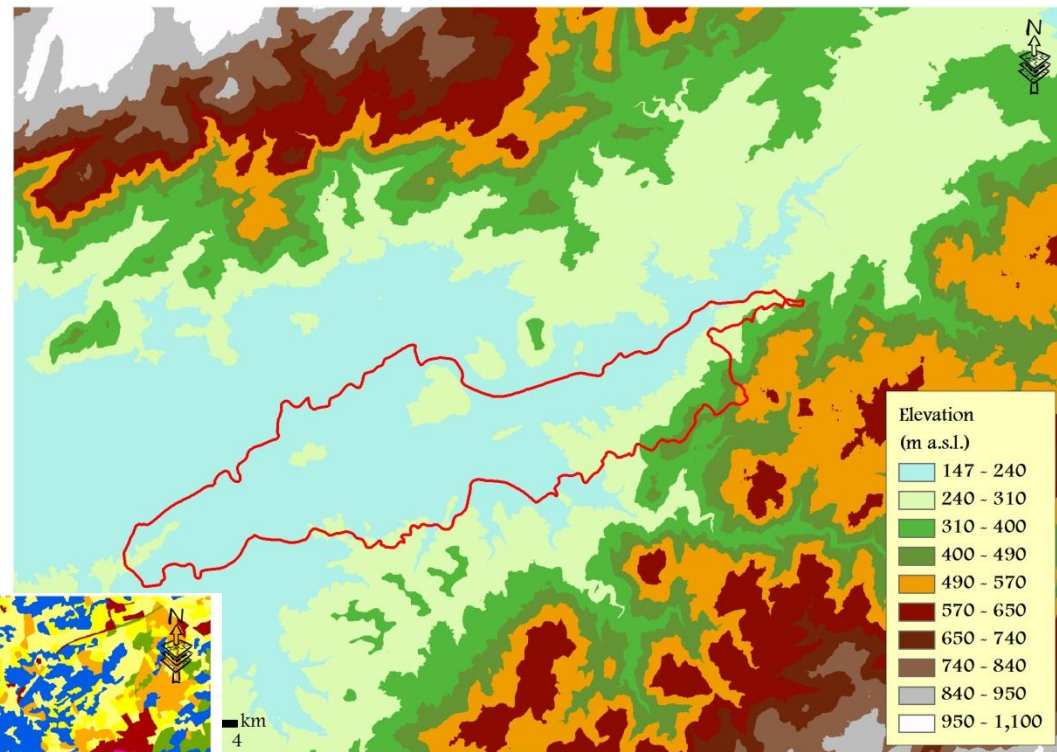



Fire Spread and Behavior Modeling

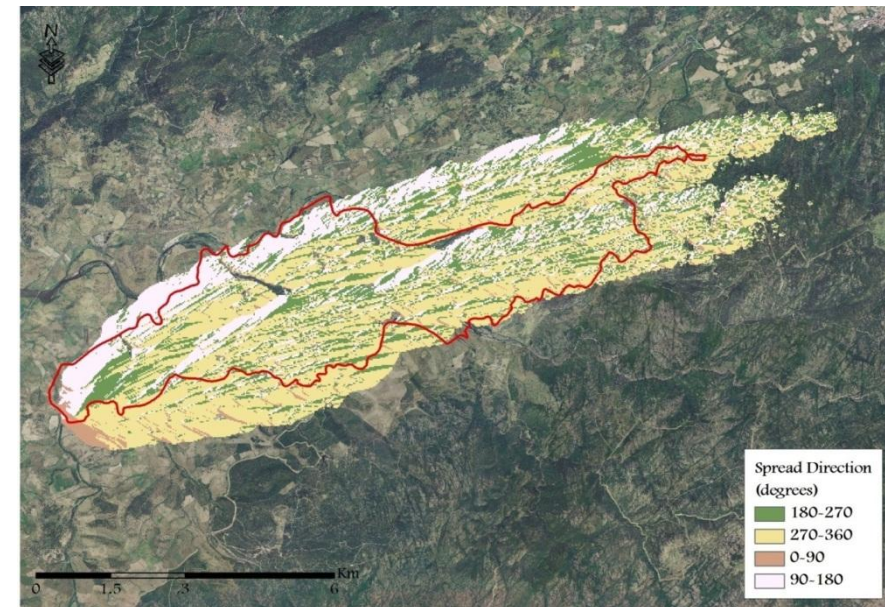
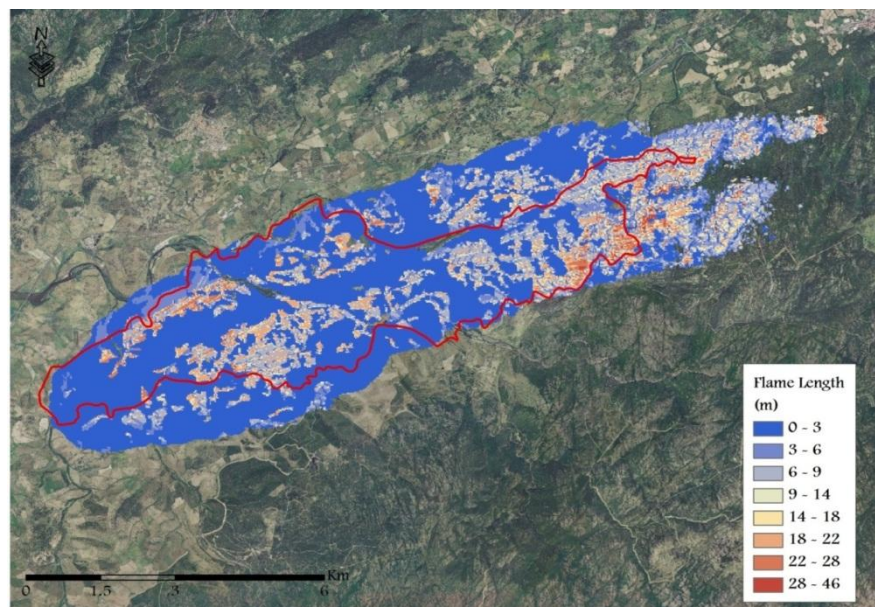
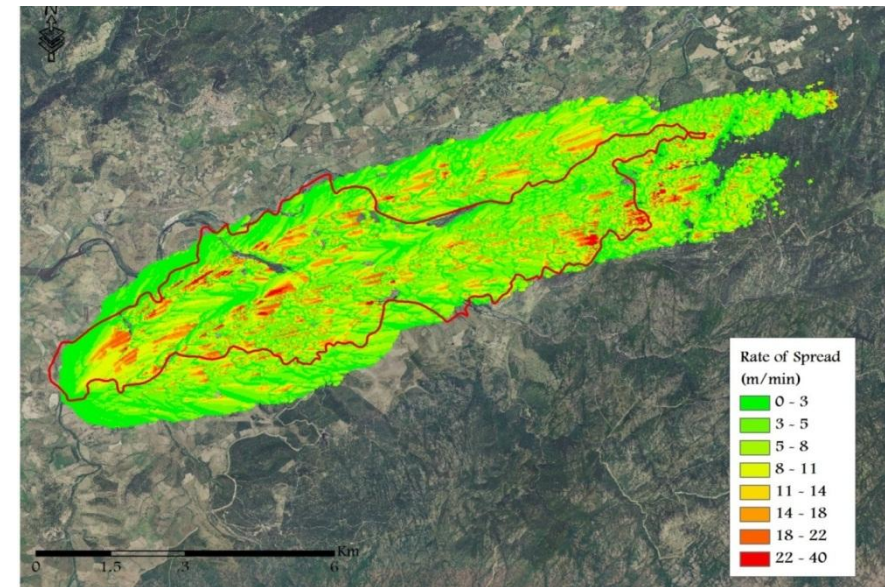
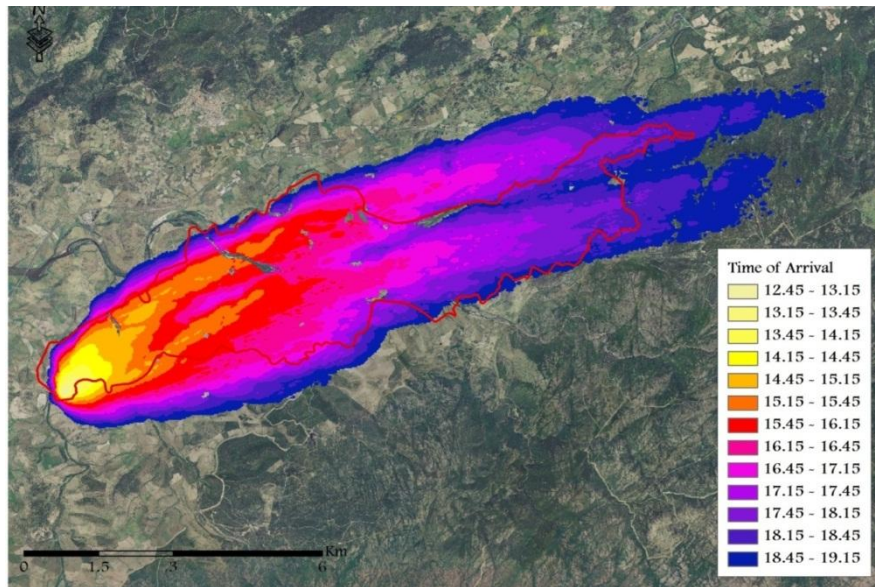

Fire Spread and Behavior Modeling

Accuracy of the simulation: about 65%

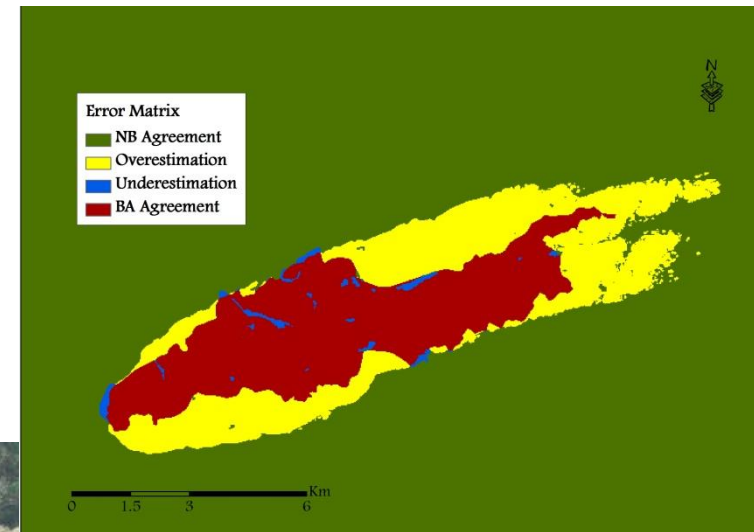
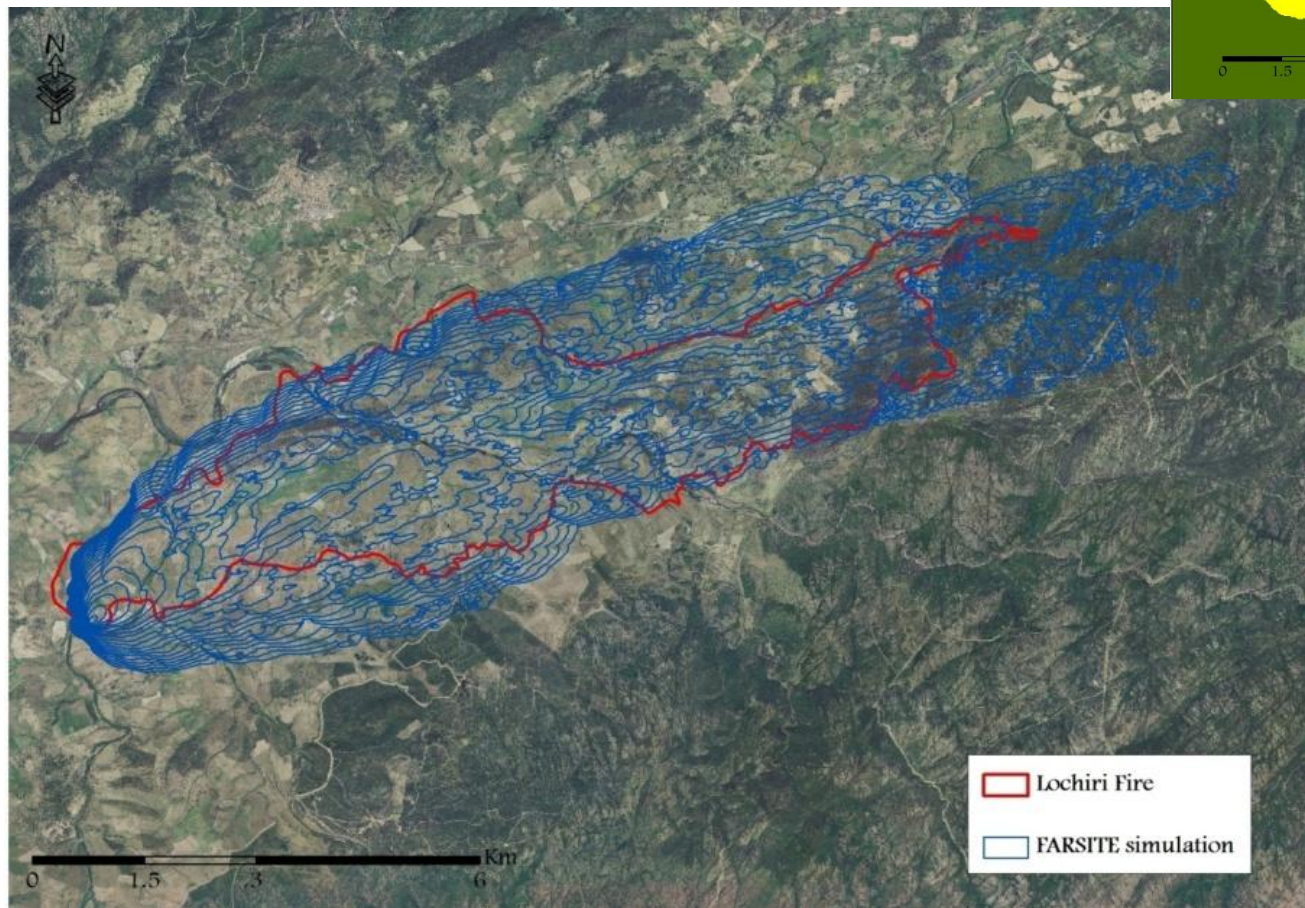

Mavuli et al. 2011; Salis et al. 2012

Fire Spread and Behavior Modeling

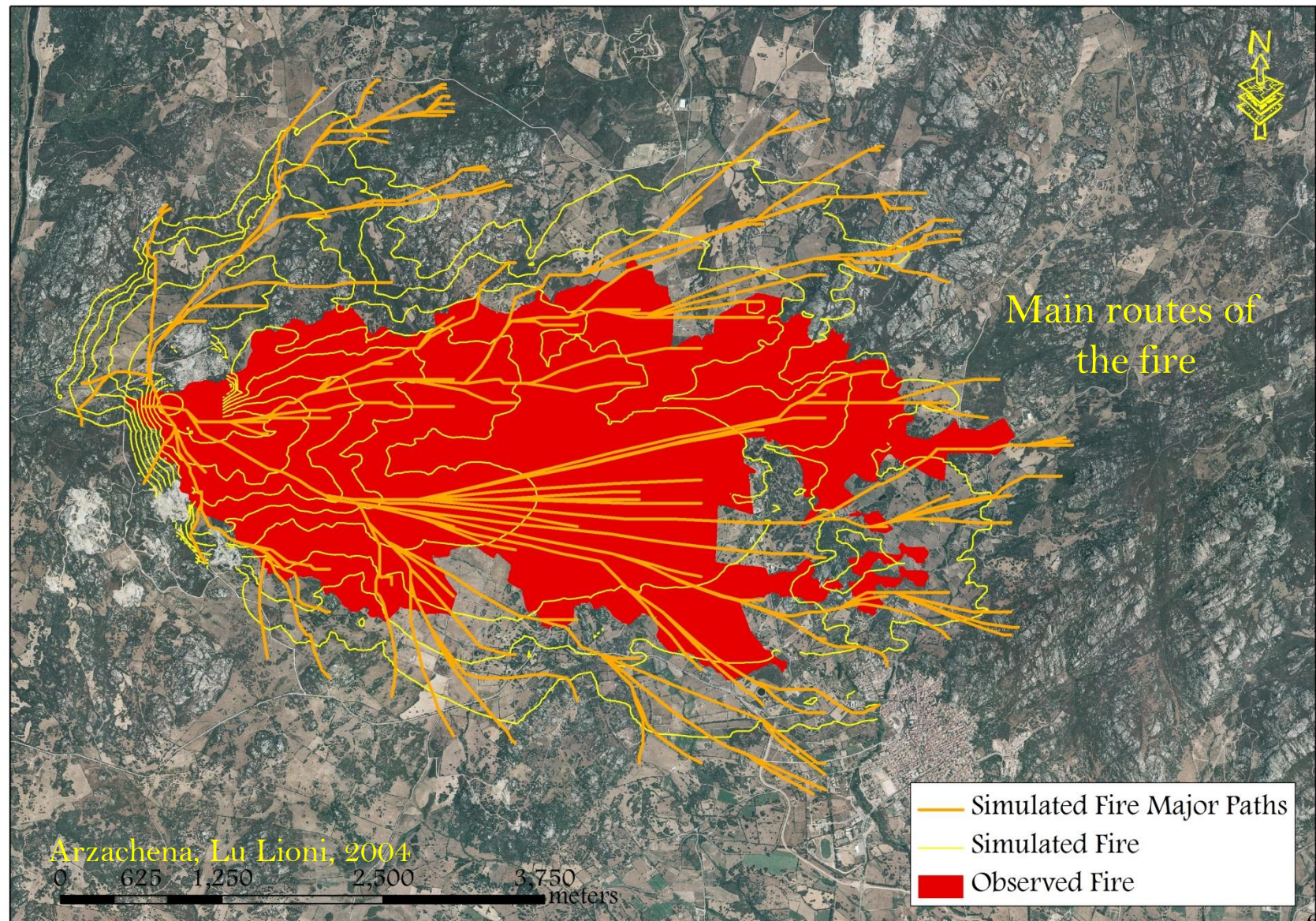

Fire Spread and Behavior Modeling

Observed vs
Simulated

Budoni, Costa di Dananzi, 2004

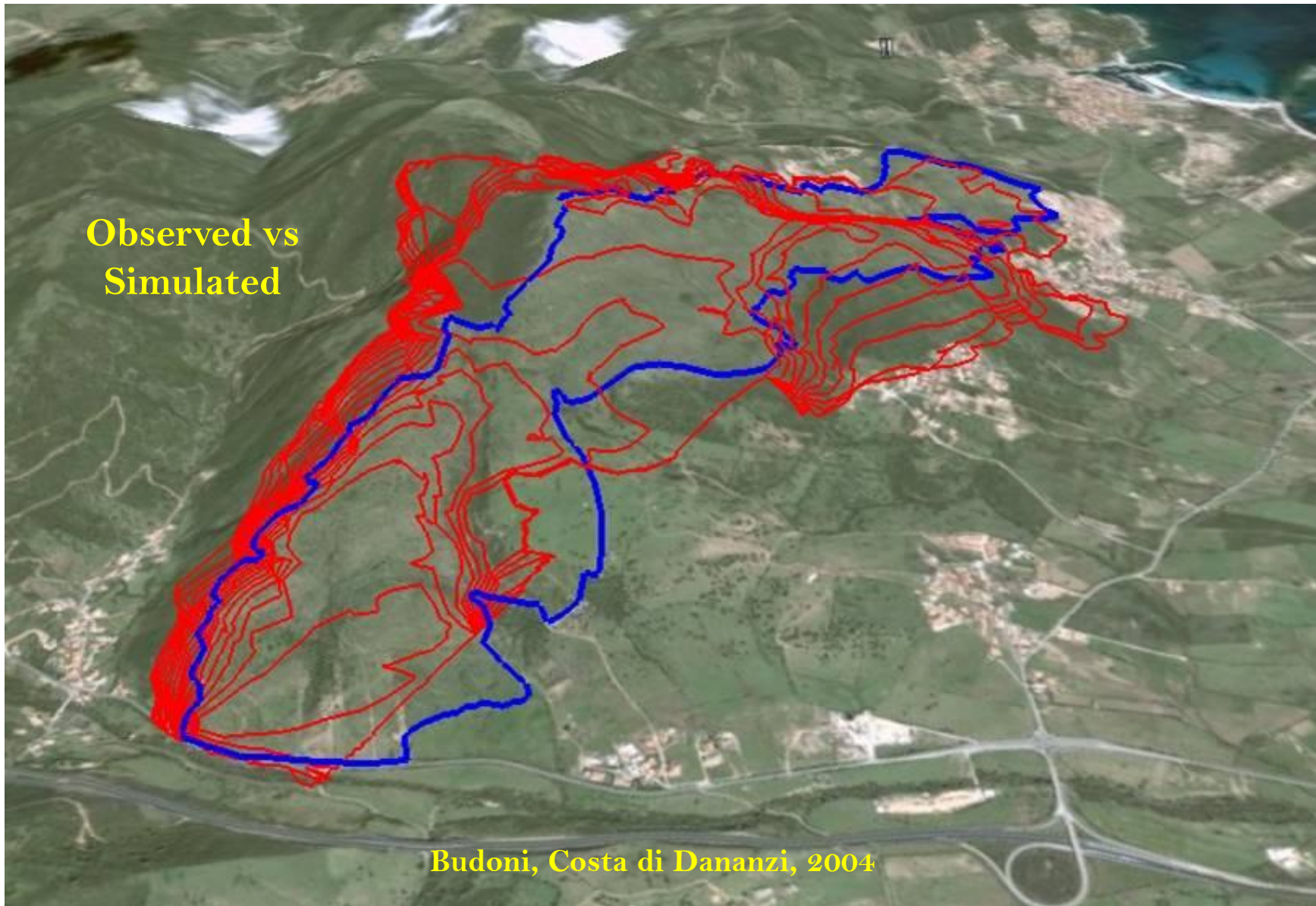

Fire Spread and Behavior Modeling

Rate of Spread

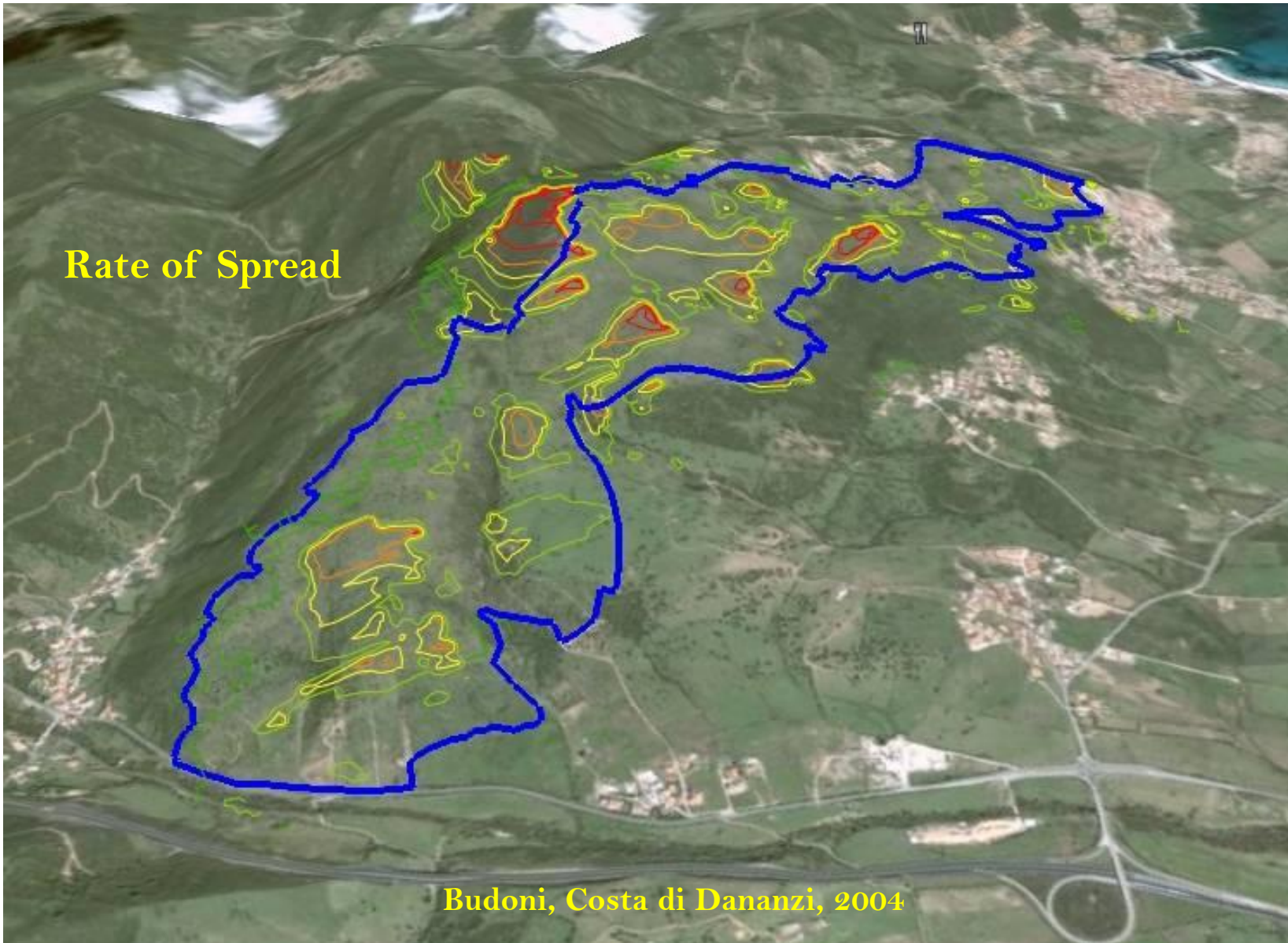

Budoni, Costa di Dananzi, 2004

Fire Spread and Behavior Modeling



Fire Spread and Behavior Modeling

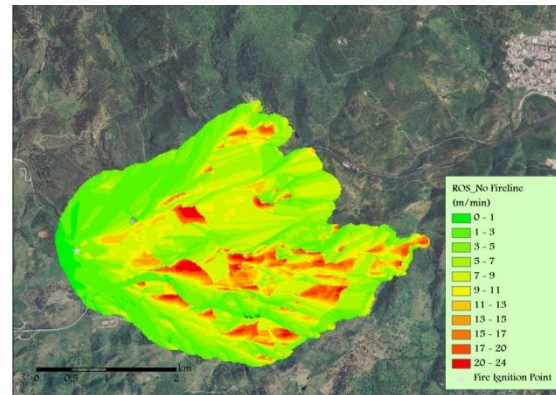
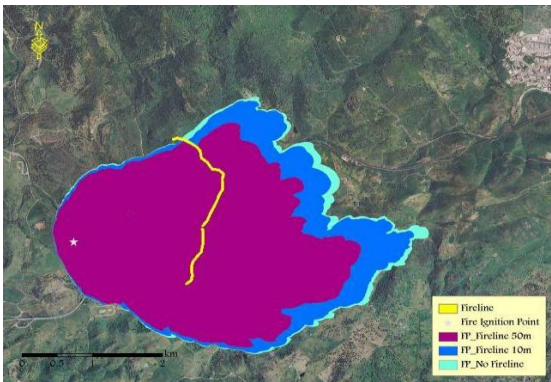
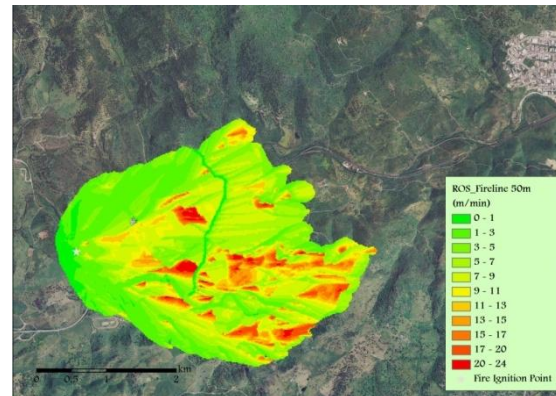
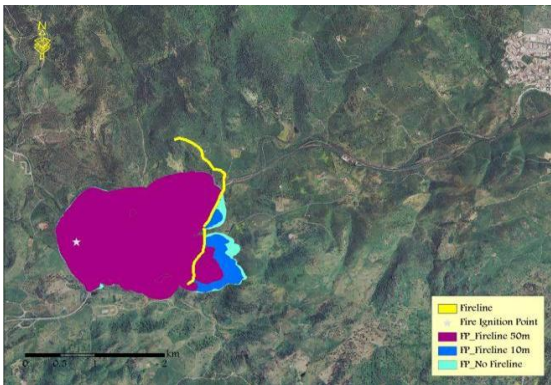

Effects of firelines of different width (0 m, 10 m, 50 m).

Comparison of fire ROS values in different situation: 50 m width fireline, no fireline



Fire Spread and Behavior Modeling

Evaluation of fire mitigation strategies

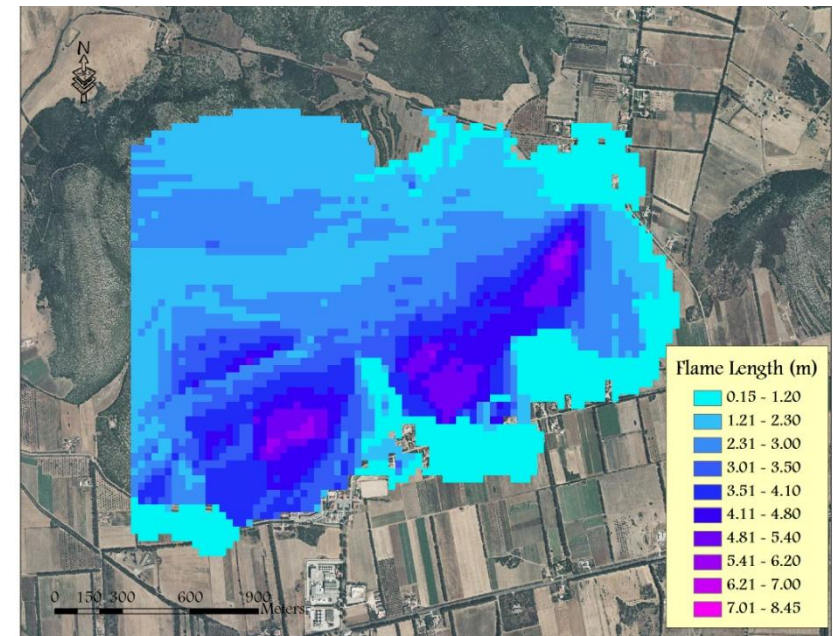
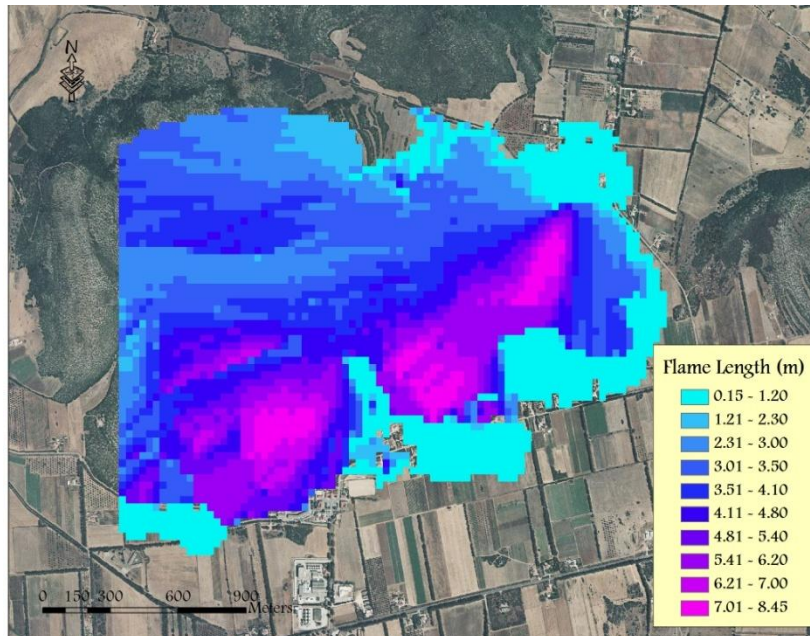

Fire Exposure Assessment in Sardinia

Methodological Framework

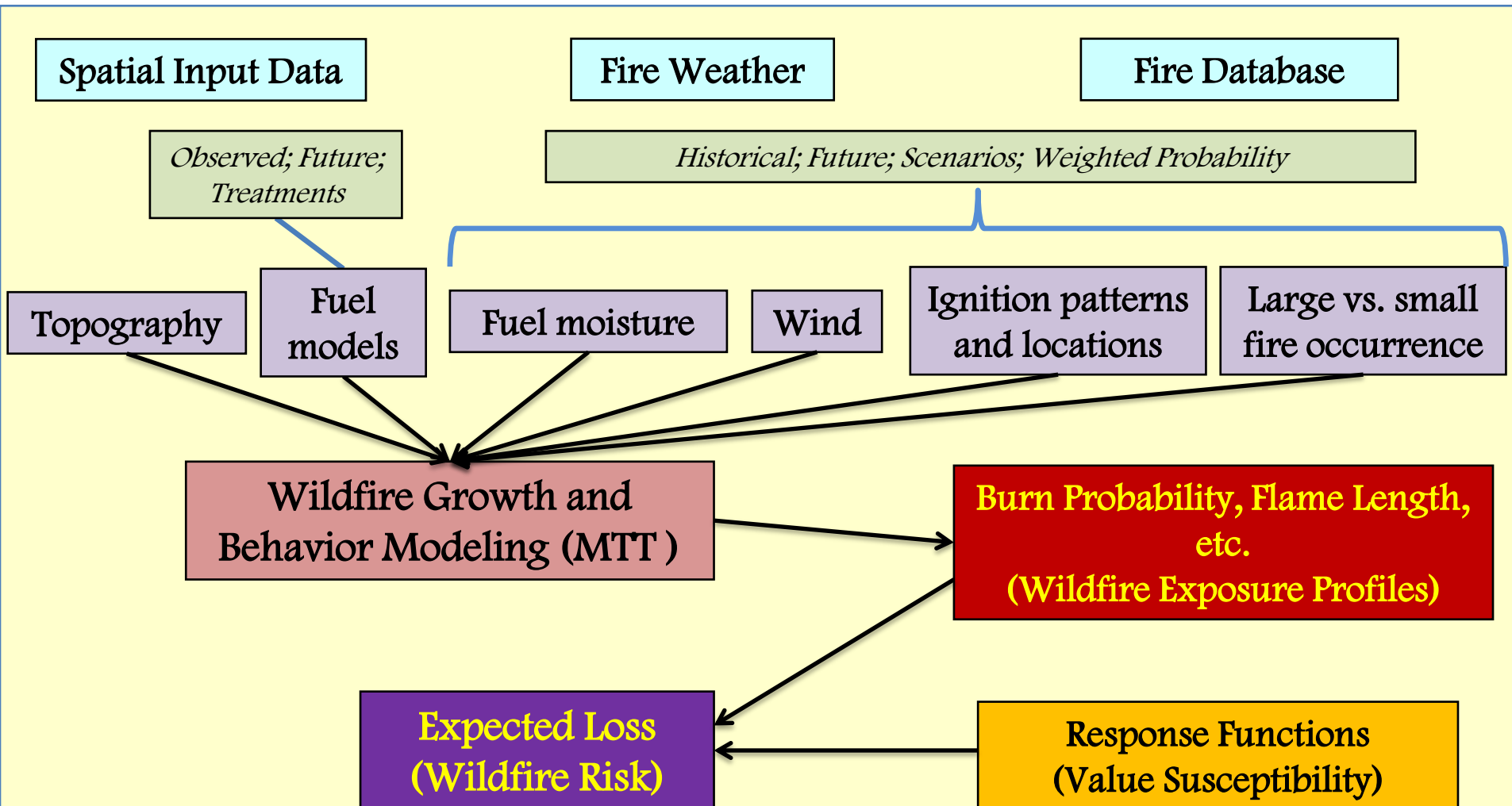

Fire Exposure Assessment in Sardinia

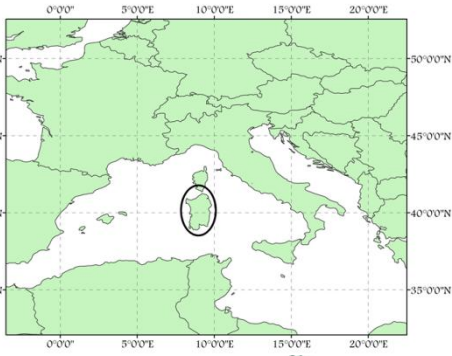

Many diverse values at risk!



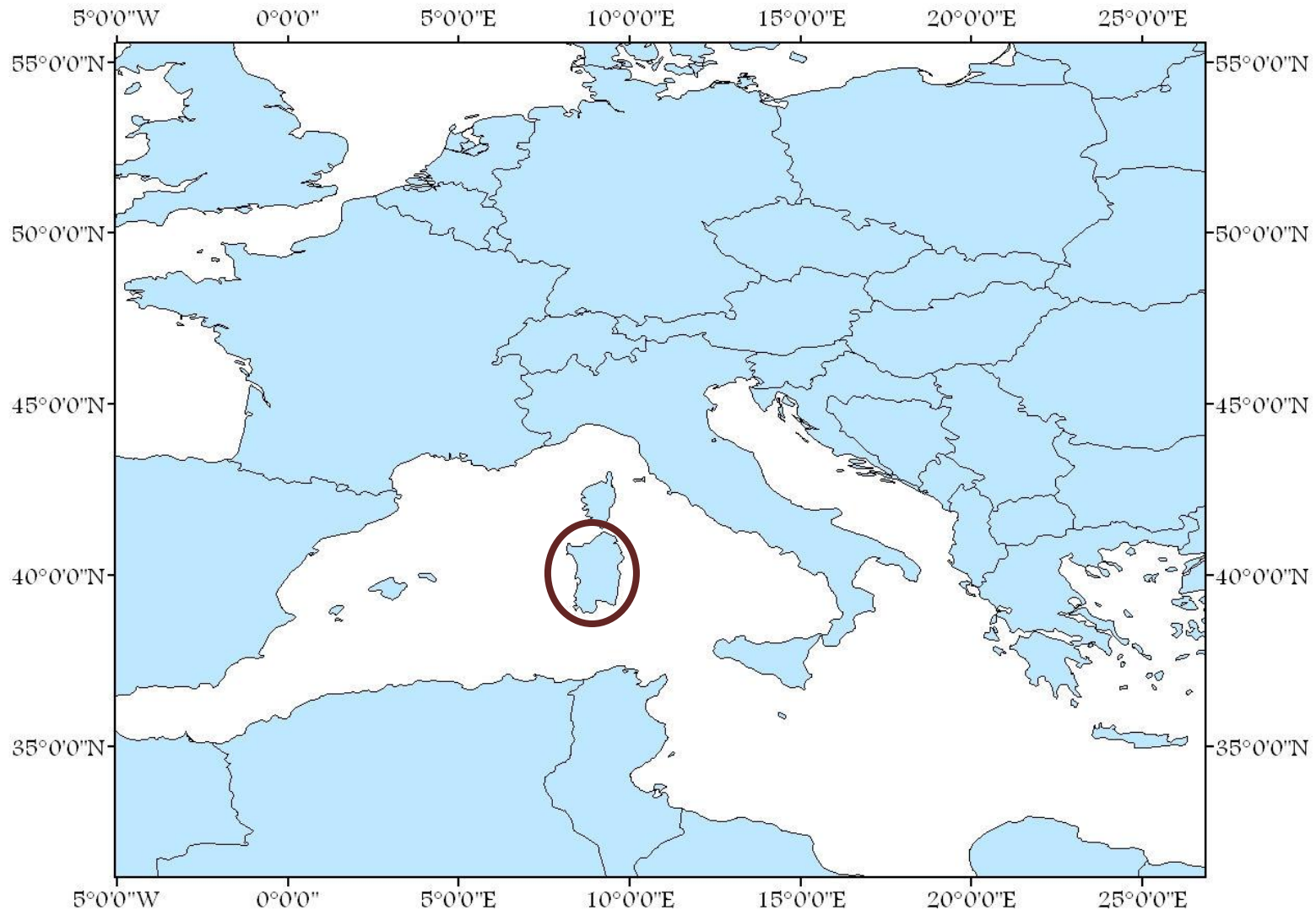

With a surface of about 24,000 km², Sardinia is located in the western part of the Mediterranean Basin and is the second largest island in the Mediterranean Sea

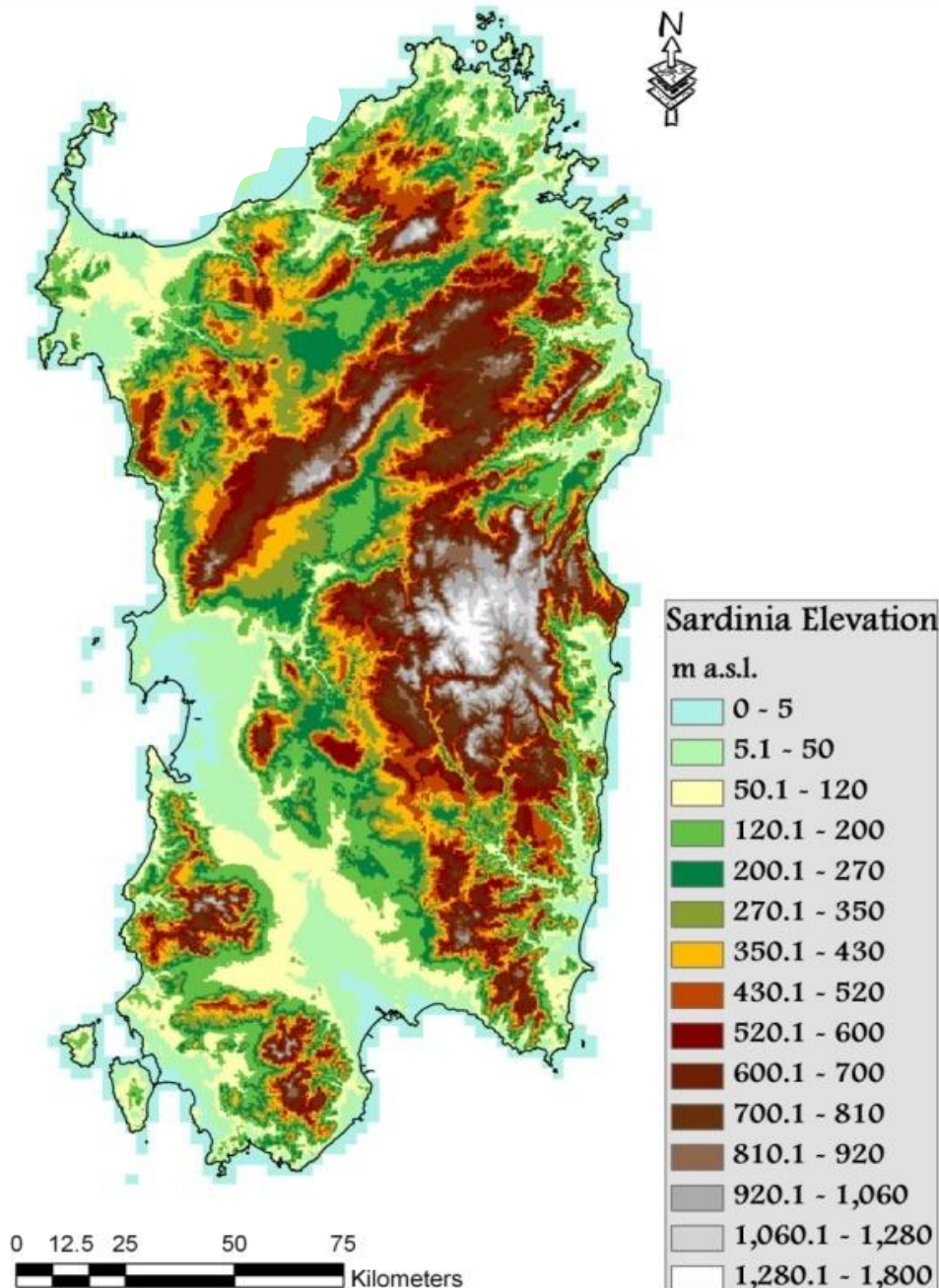

Sardinian Orography

The orography is generally hilly, with the highest point being 1834 m a.s.l. (Gennargentu) in the center of the island.

The largest plains are located in the western parts of the island

Sardinian Vegetation

Wood and forest represent approximately 16% (year 2000) of the Sardinian vegetation, and are mainly represented by *Quercus ilex*, *Quercus suber*, *Quercus pubescens*. At higher elevation the oak formation mainly merges with *Castanea sativa*.

The coniferous stands (represented by *Pinus* spp.) are limited (3%).

The most important forest vegetation type (28%) is represented by Mediterranean maquis and garrigue.

Urban and anthropic areas cover about 3% of Sardinian landscape.

The remaining fraction is represented by pastures and agricultural areas (49%), and by other land uses.

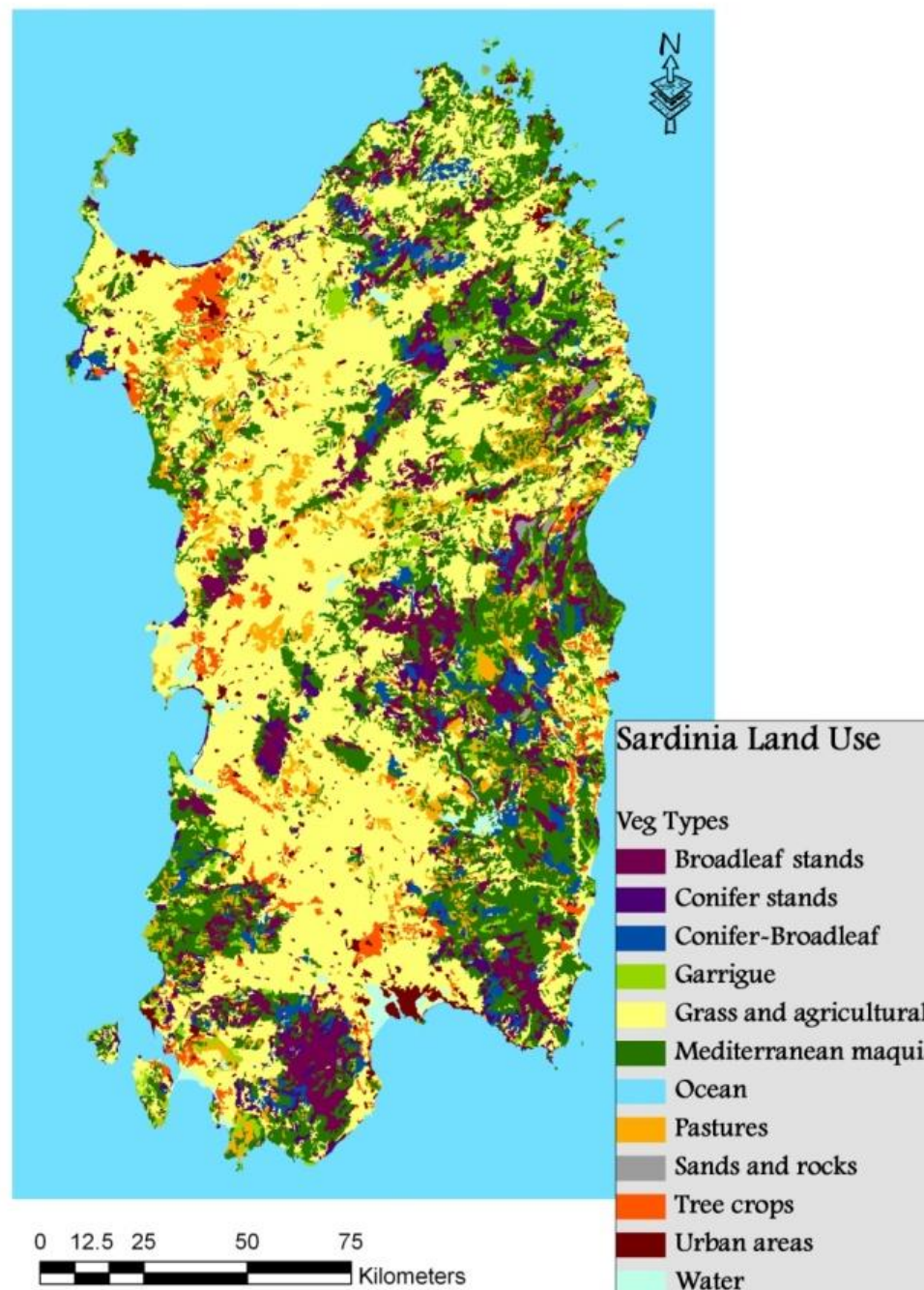

Sardinian Climate

The climate is Mediterranean sub-arid, with a remarkable water deficit from half May until half September.

The most of annual rainfall amounts (approximately 700 mm on average) occur in fall and winter.

The Sardinia mean annual temperature along the coast line is approximately 17 °C, mostly in the southern part of the island.

During the summer season, Sardinia experiences peaks of temperature higher than 30 °C.

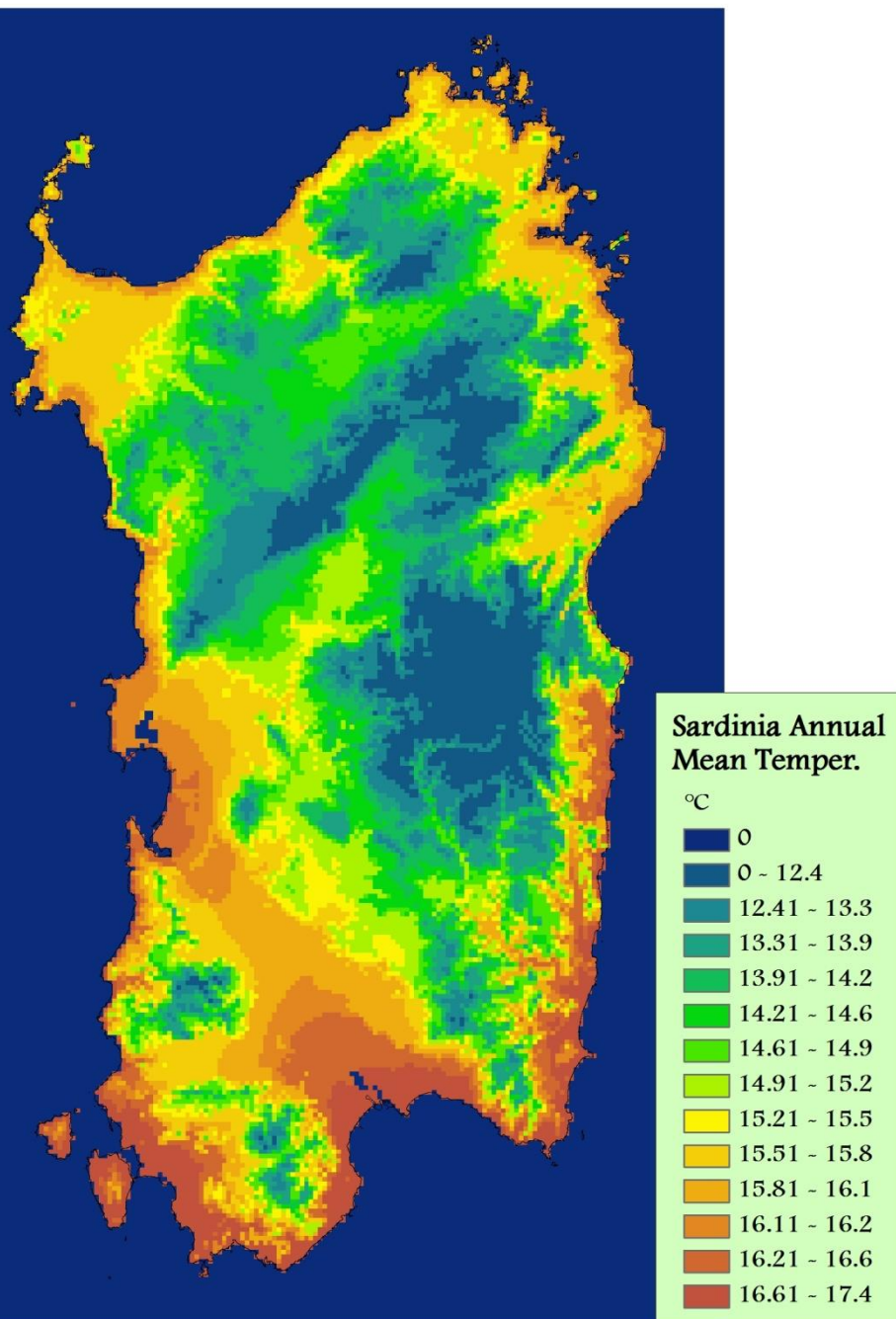

Sardinian fires

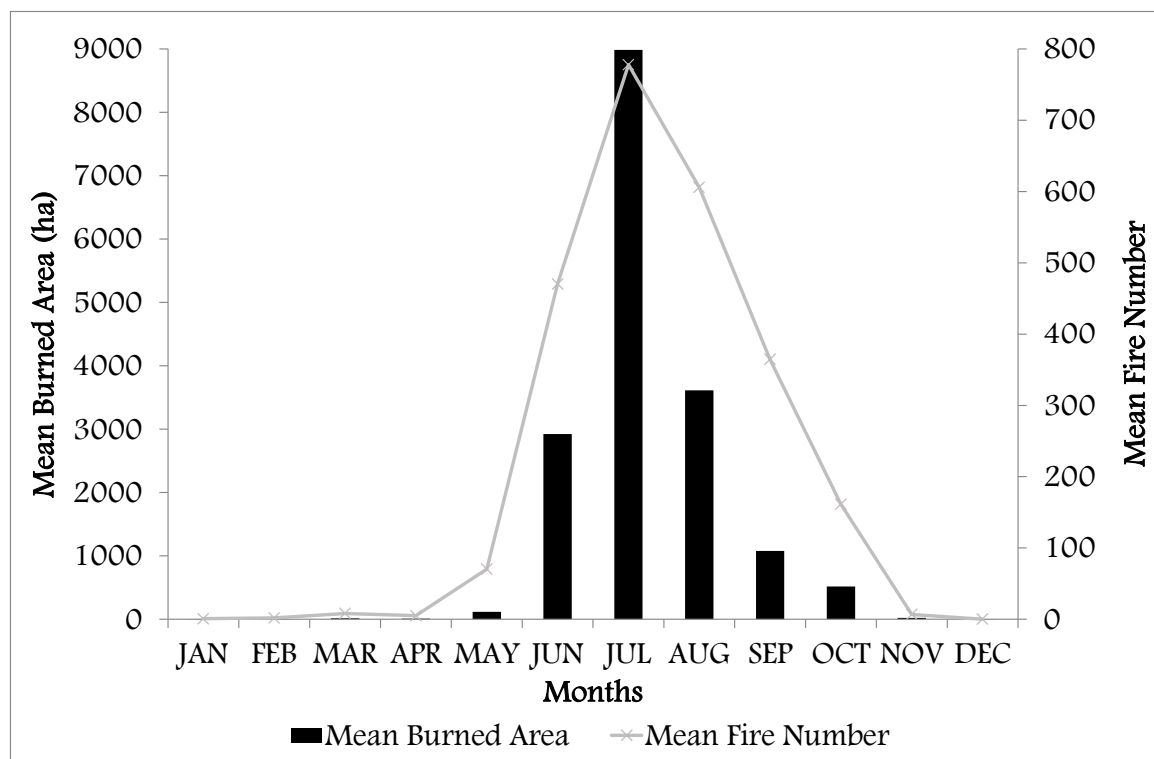
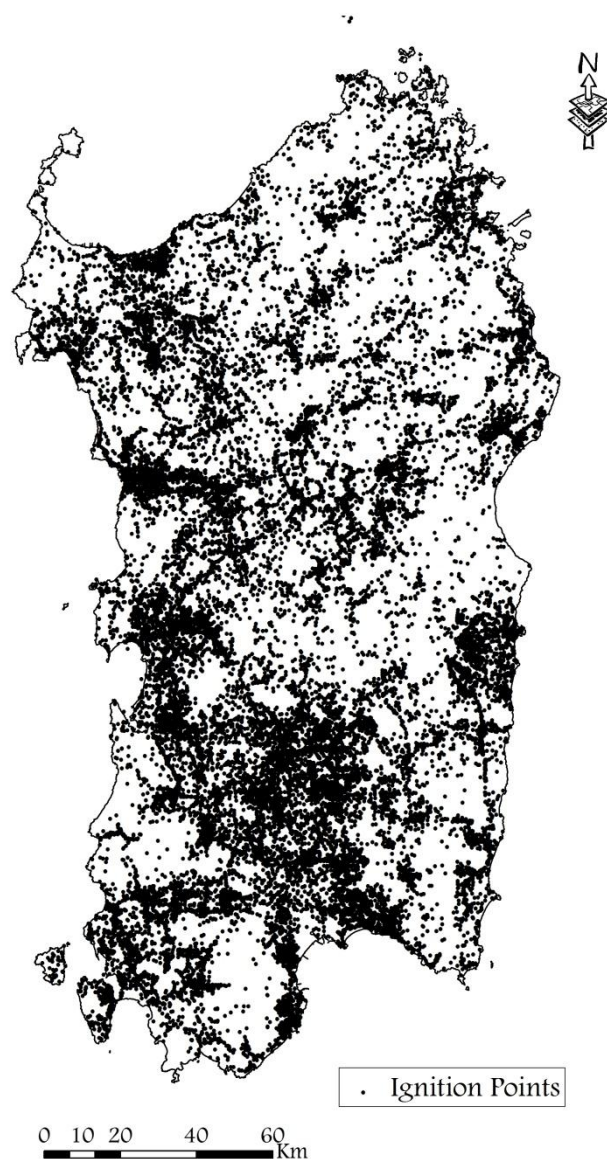

The wildfire issue is commonly concentrated in the period June-September

On average, in recent years Sardinia experienced about 2,500 wildfires per year, with an area burned close to 18,000 ha

Sardinian fires

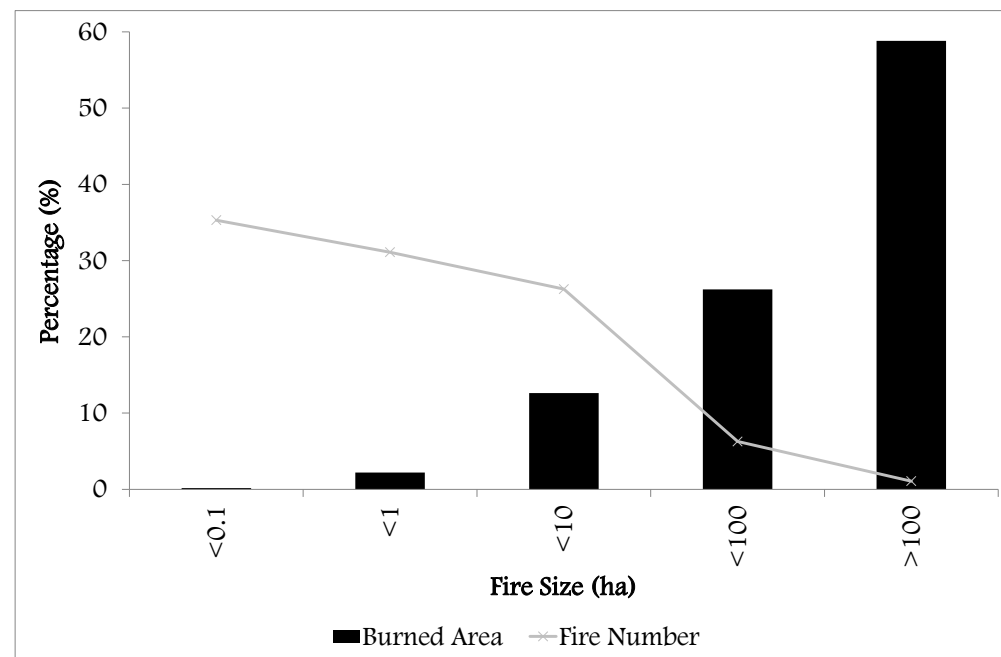

Wildfires with size > 100 ha account for only 2% of fires, but for about 60% of the total area burned in the island

Such large events are very often driven by strong winds and severe environmental conditions (high temperatures, low RH, etc.)

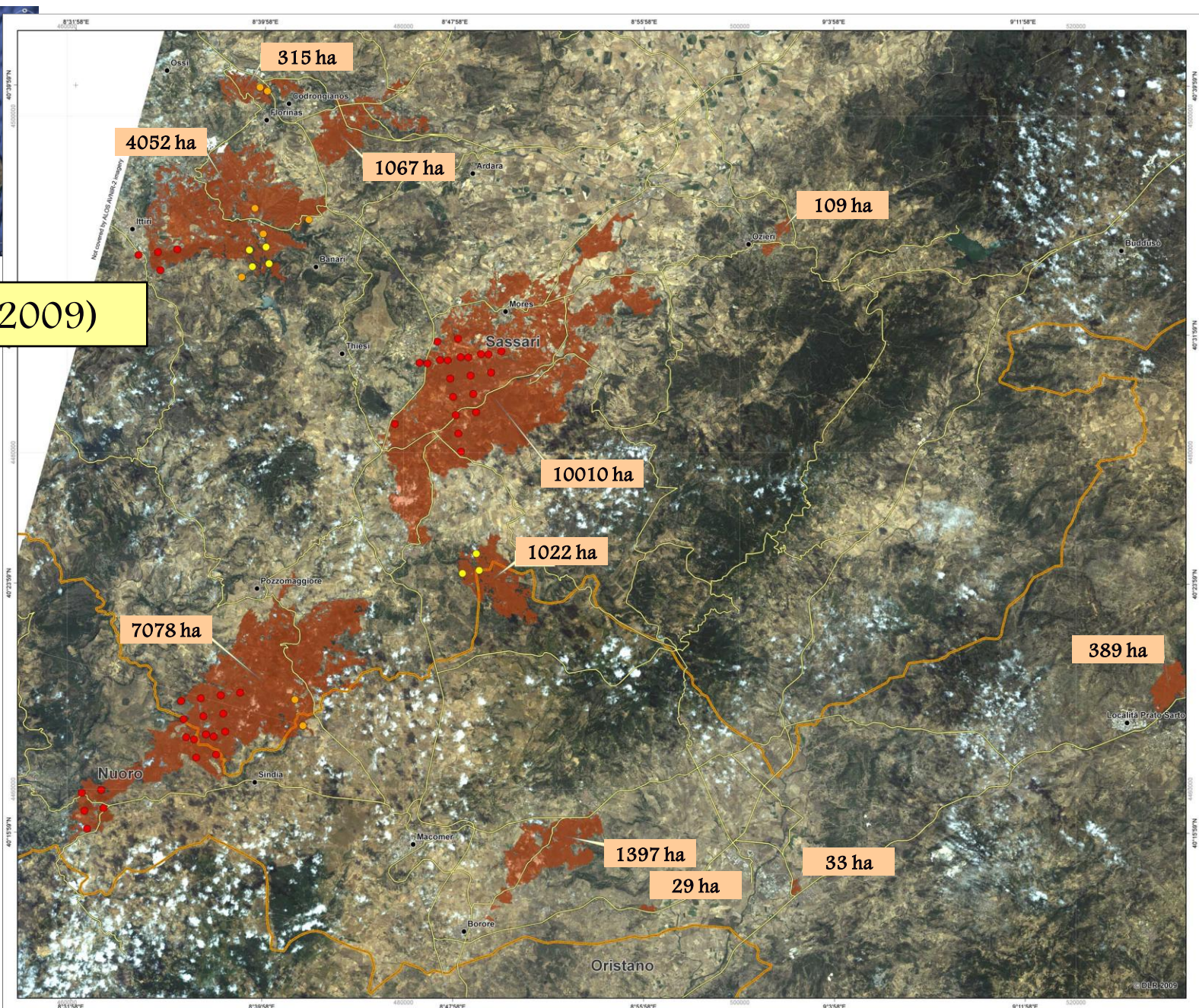
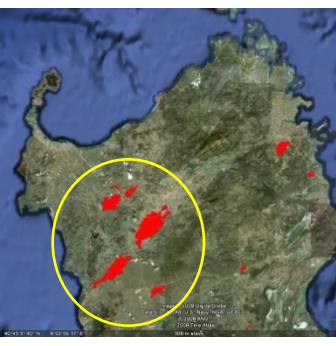

(23~24 July 2009)

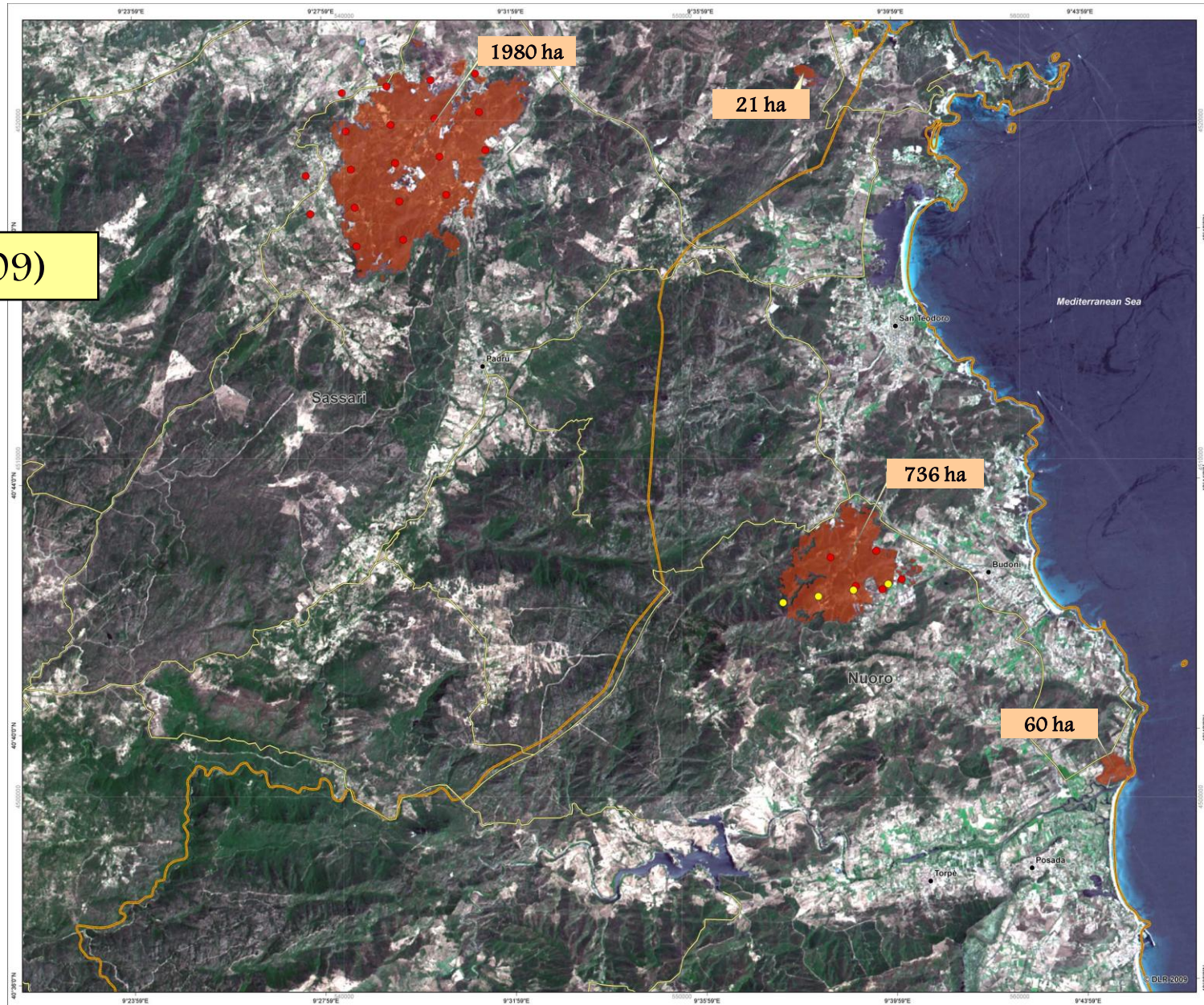
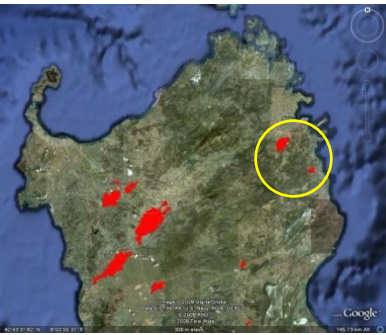

(23~24 July 2009)

(23~24 July 2009)



2 persons died and several injured; 25,000 ha burned in 30~36 hours by 9 wildfires > 1,000 ha; huge damages to flora, fauna, urban areas, anthropic values, and farms

Spatial Input Data

Historical Fire Database

Weather

INPUTS

Topography

Fuels

Ignition patterns and locations

Burn period

Wind

Fuel moisture

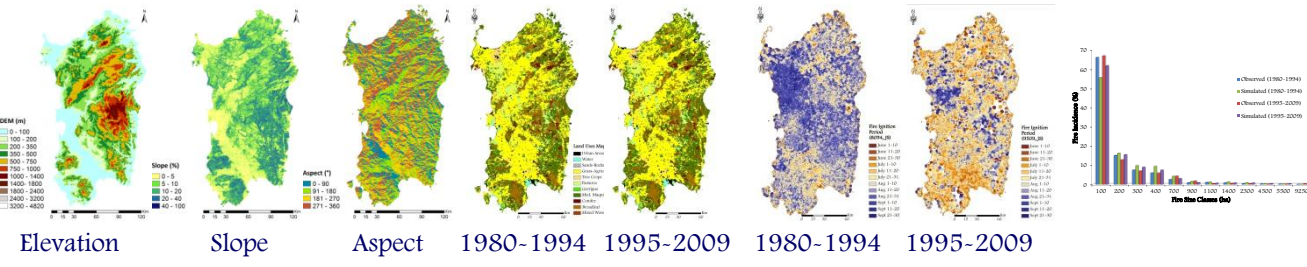

Study period	(1980-1994)	(1995-2009)
Wind Speed (km h ⁻¹)	29.0	29.0
Temperature (°C)	36.0	36.5
Rain (mm)	0	0
1 hr dead FM (%)	7	7
10 hr dead FM (%)	9	9
100 hr dead FM (%)	11	11
Wind Direction (°)	315 (35%); 225 (22%); 270 (19%); other (24%)	315 (40%); 225 (24%); 270 (14%); other (22%)

SIMULATIONS

Randig, MTT algorithm (Finney 2002)
 Simulation of 100,000 fires, randomly sampling from historical weather, fuel moisture, ignition patterns, burn periods (study period 1995~2009)
 Data resolution: 250 m (100 m) over 24,000 km²

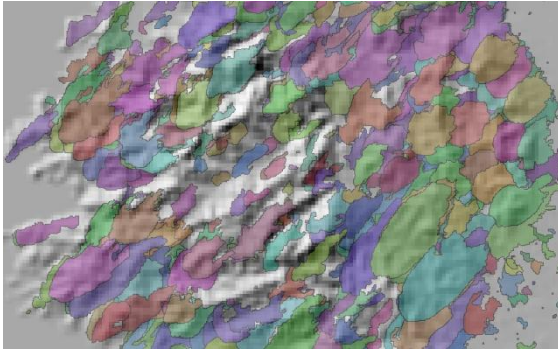

OUTPUTS

Burn Probability (BP)
 Conditional Flame Length (CFL)
 Fire Size (FS)
 Fire Potential Index (FPI) and more...

(Salis et al. 2013 - IJWF)

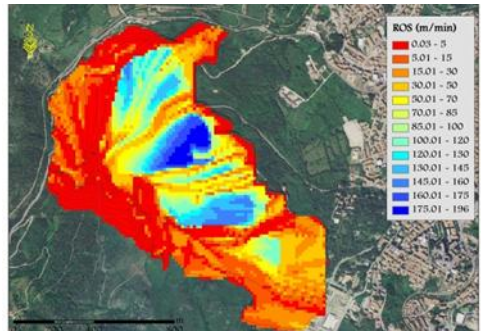

Fire Exposure Assessment in Sardinia

Identification of areas characterized by high burn probability

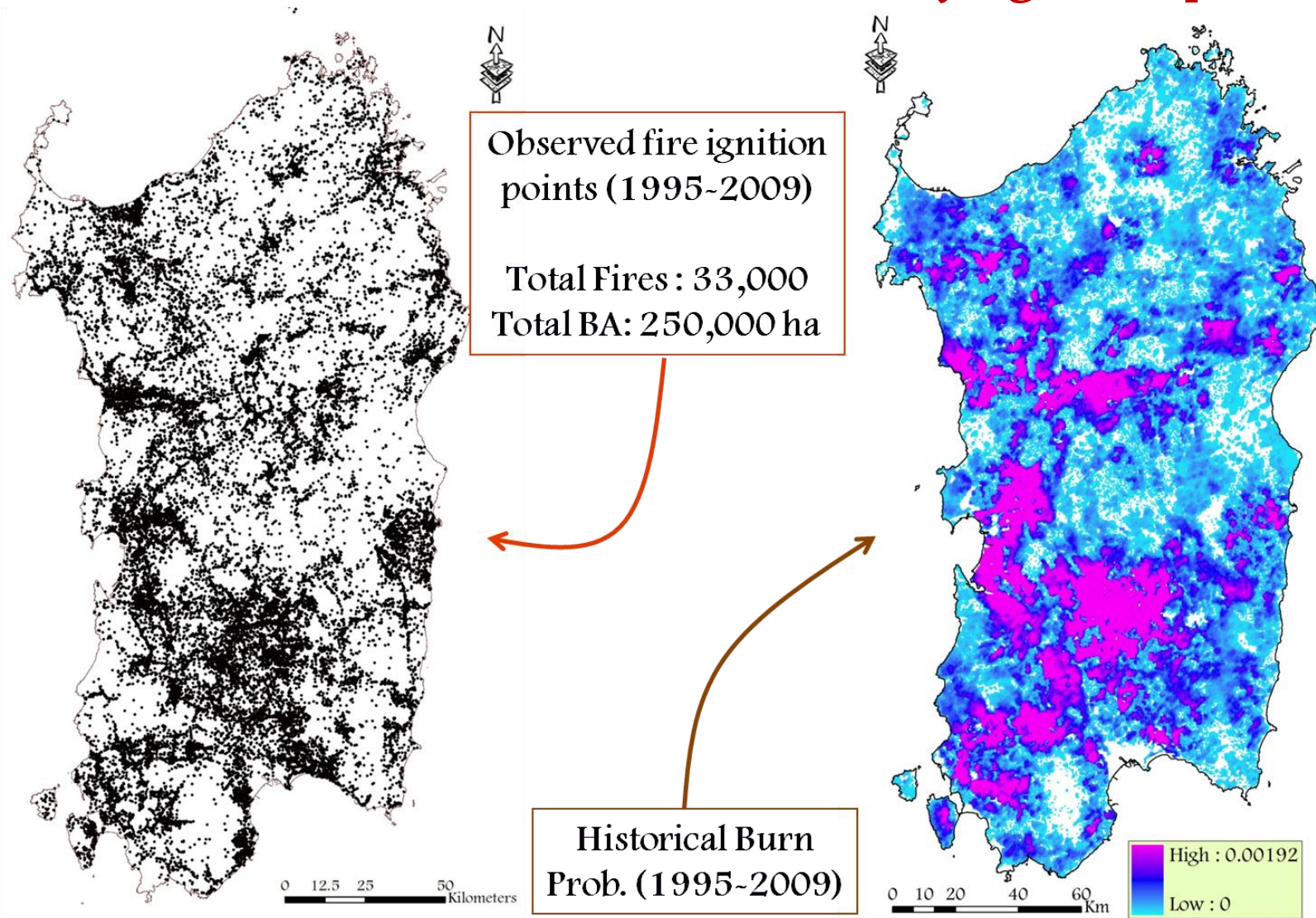

Fire Exposure Assessment in Sardinia

Identification of areas characterized by high fire exposure

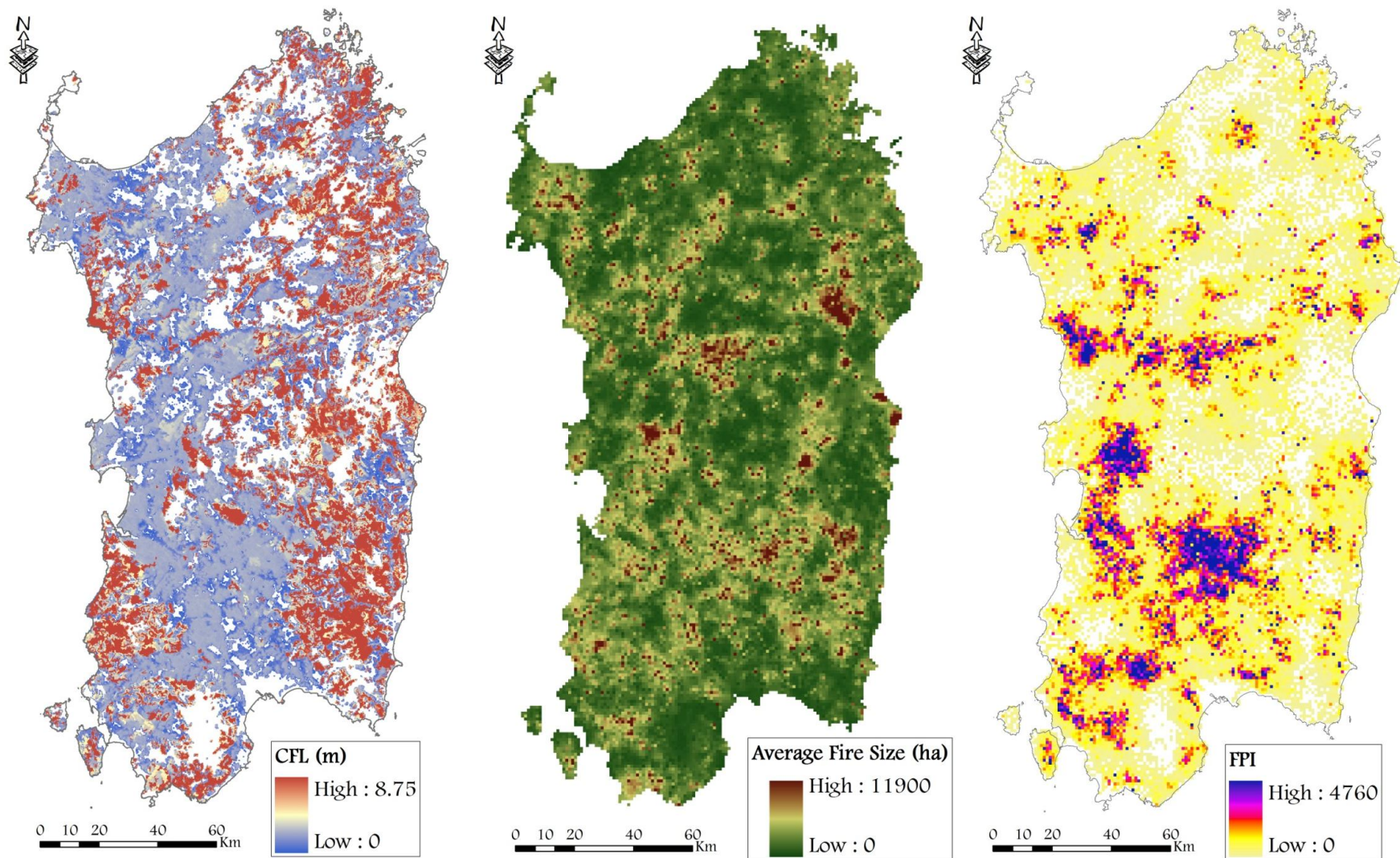

(Salis et al. 2013 ~ IJWF)

Fire Exposure Assessment in Sardinia

Causes of Wildfires

Strong role played by humans in igniting fires

Difference between “historical” and random fire ignitions occurrence obtained with RANDIG

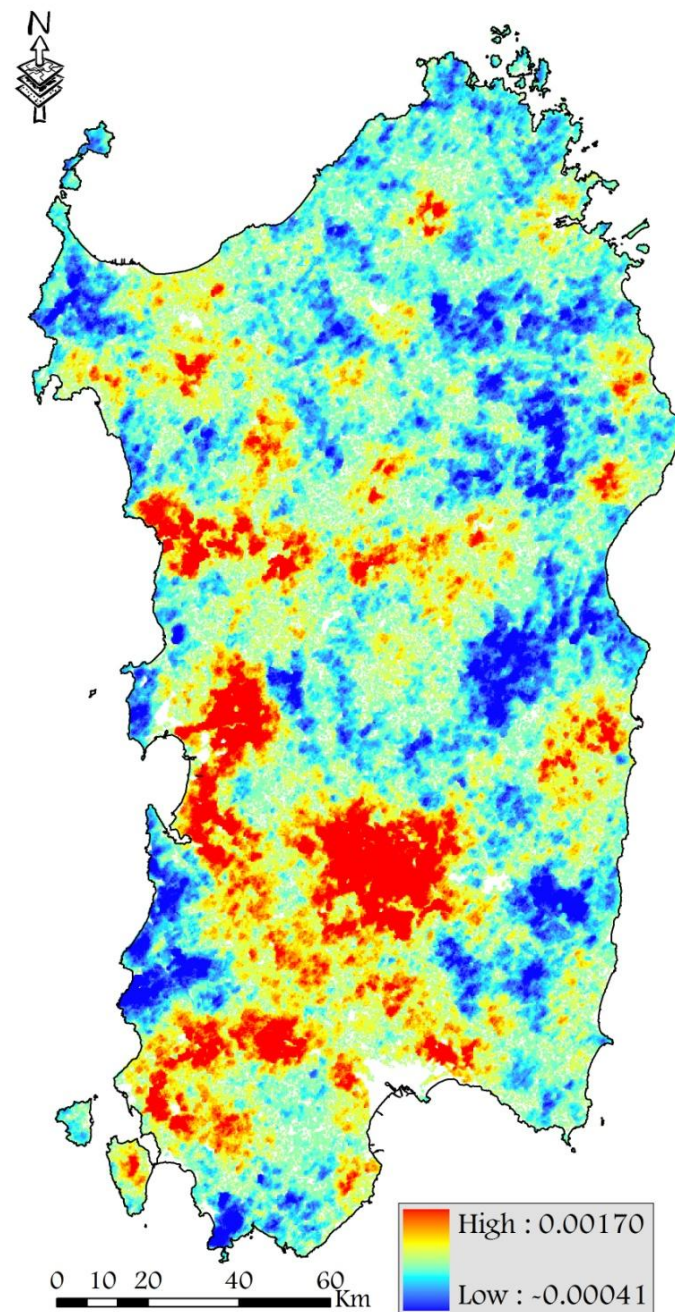
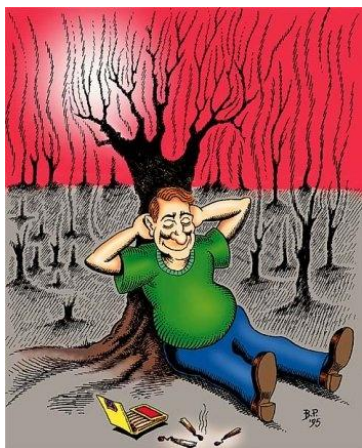

Fire Exposure Assessment in Sardinia

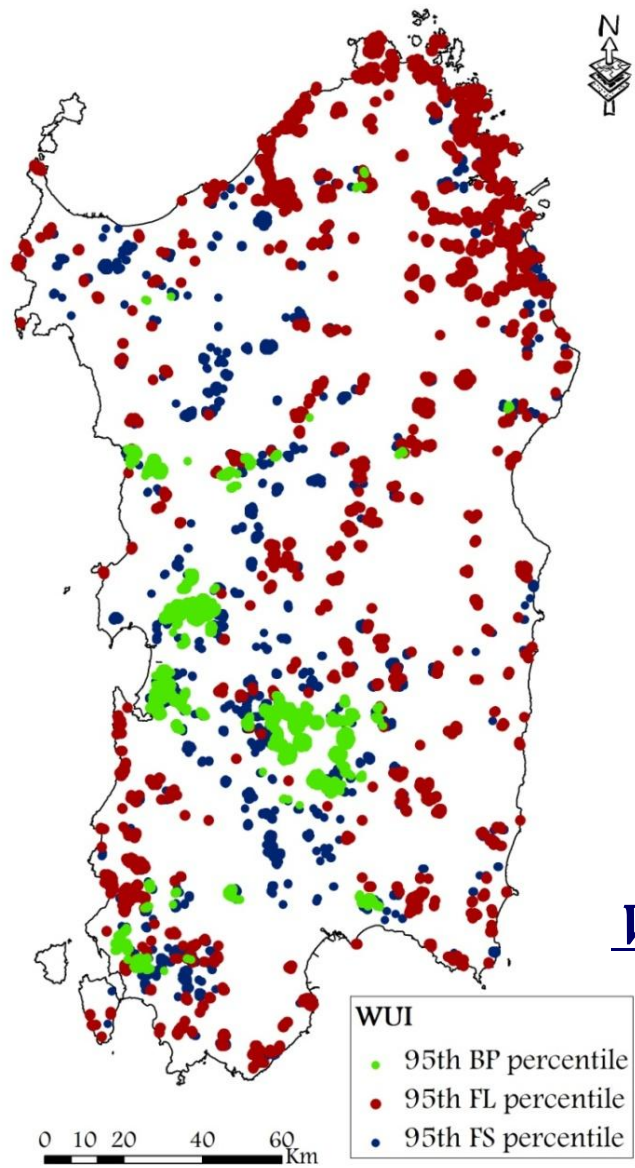

WUIs

(Salis et al. 2013 - IJWF)

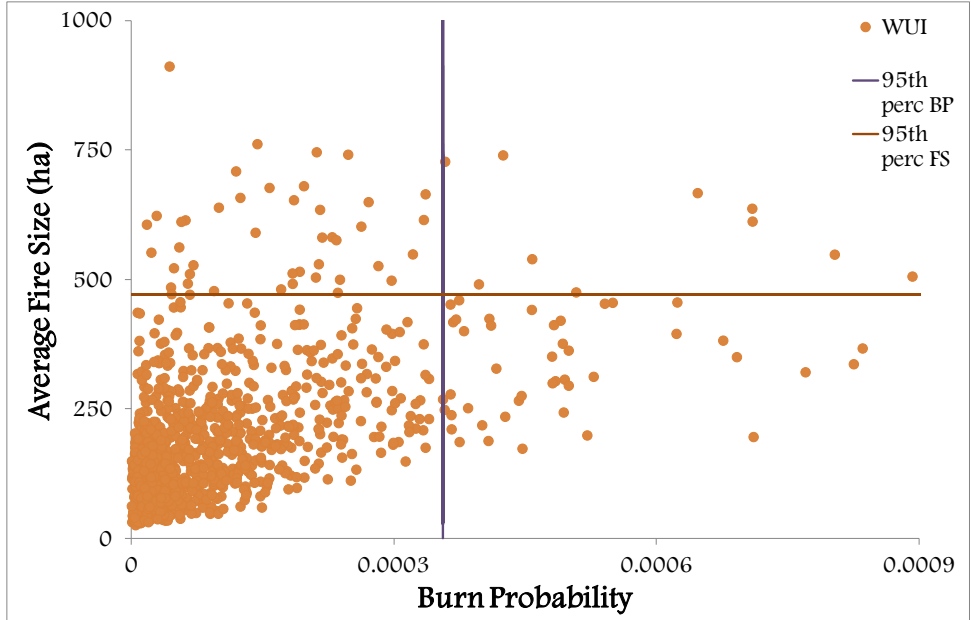
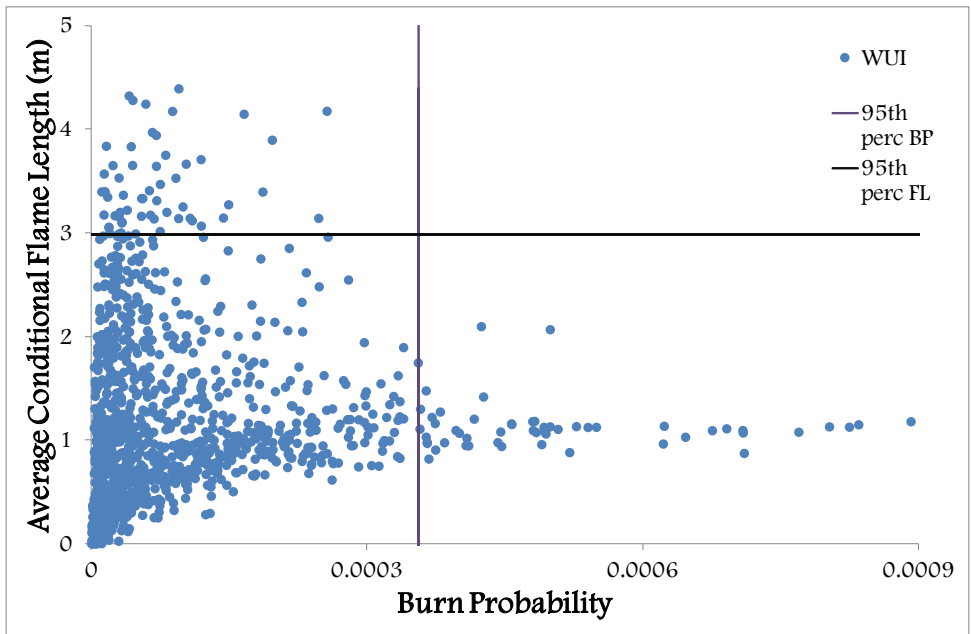

Fire Exposure Assessment in Sardinia

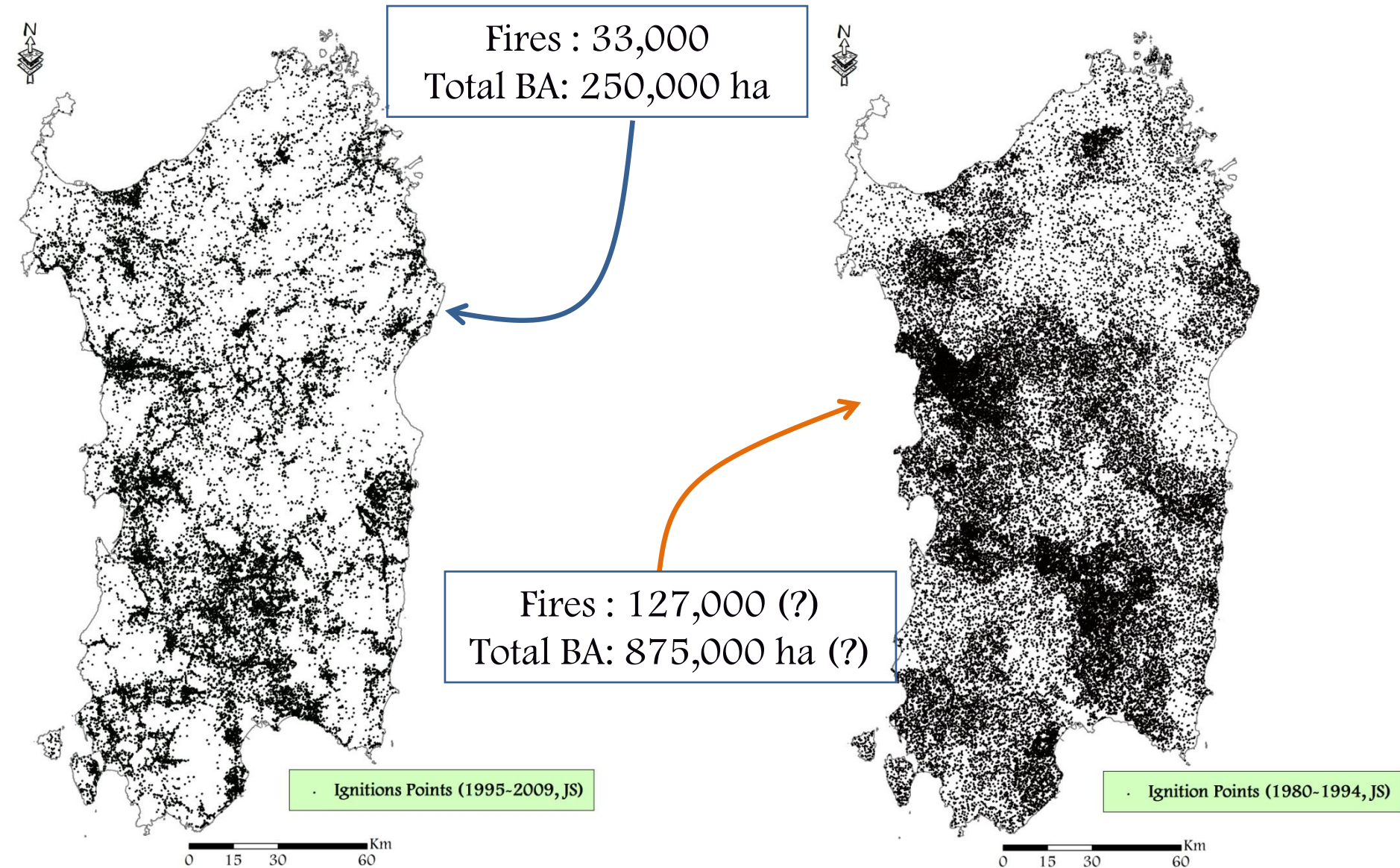

Fire Exposure Assessment in Sardinia

Fire exposure varies depending on the study period

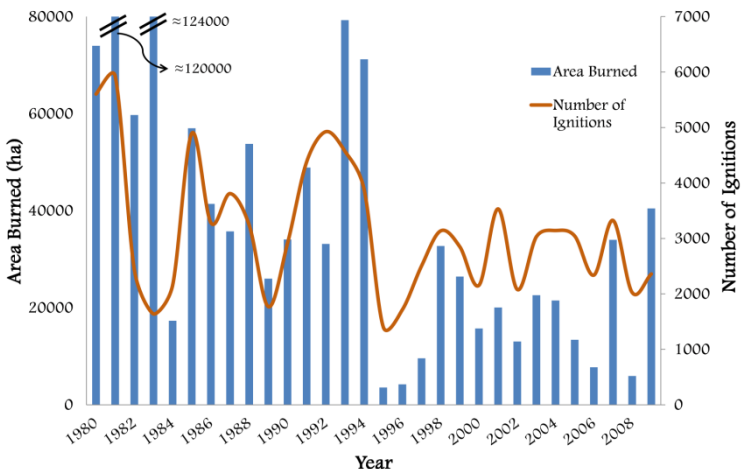
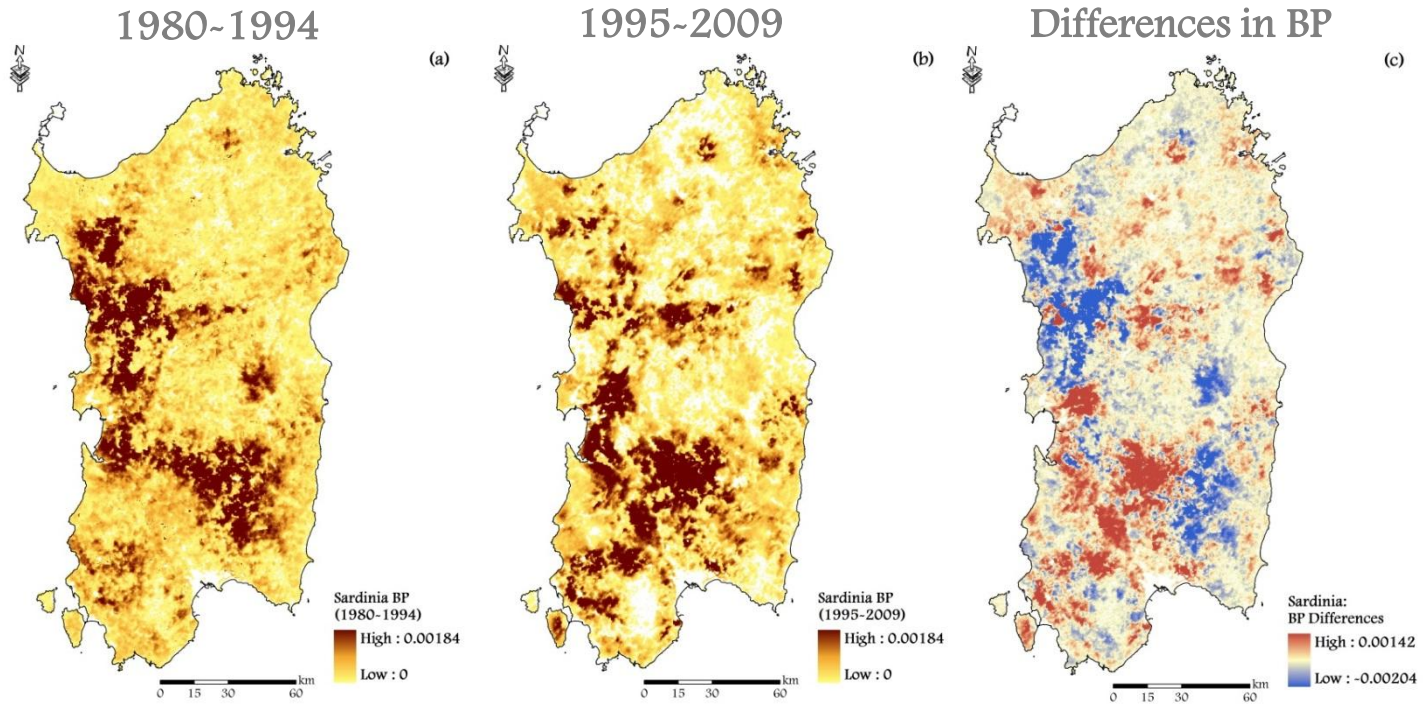

Strong reduction in FN and AB

Increase of fire ignitions nearby urban interfaces and agricultural areas

Anticipation of the fire seasons of about 15 days

Improvements in fire suppression capacity

Fire Exposure Assessment in Sardinia

Anthropic Areas (WUIs, beaches) observed an overall increase in BP in recent years



(Salis et al. 2014 ~ NHAZ)

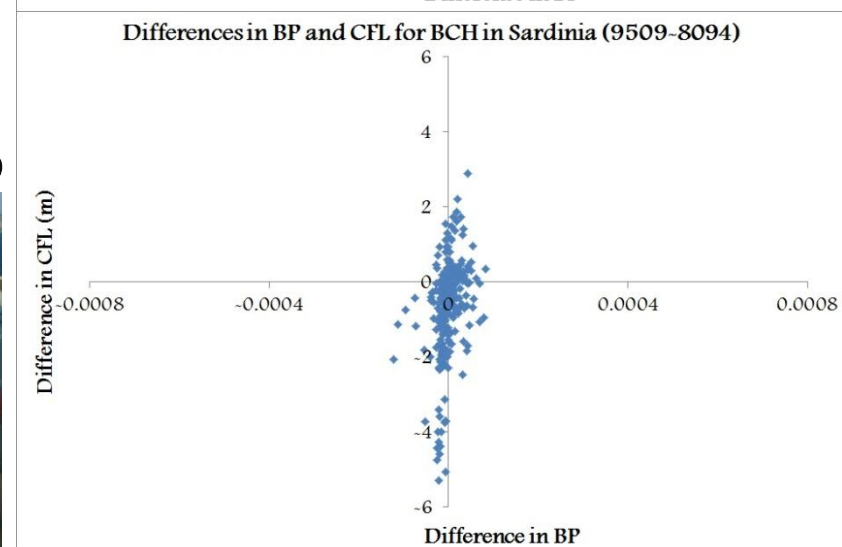
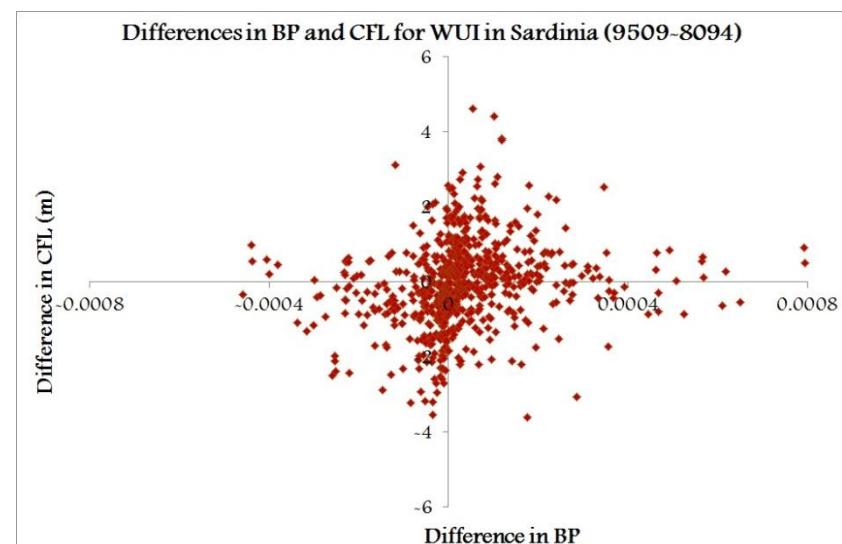

Fire Exposure Assessment in Sardinia

Fire exposure varies depending on the time of the year

(variation in fire-related factors (fuel moisture, fuel load, weather, ignitions, etc.))

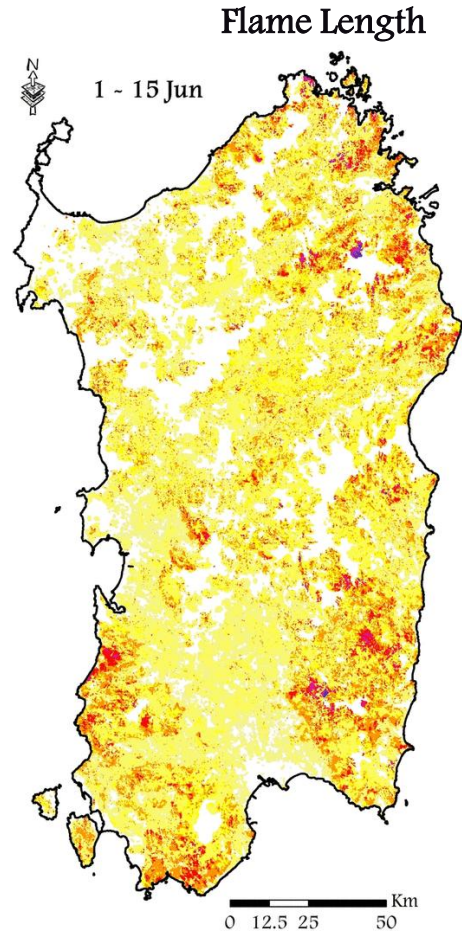
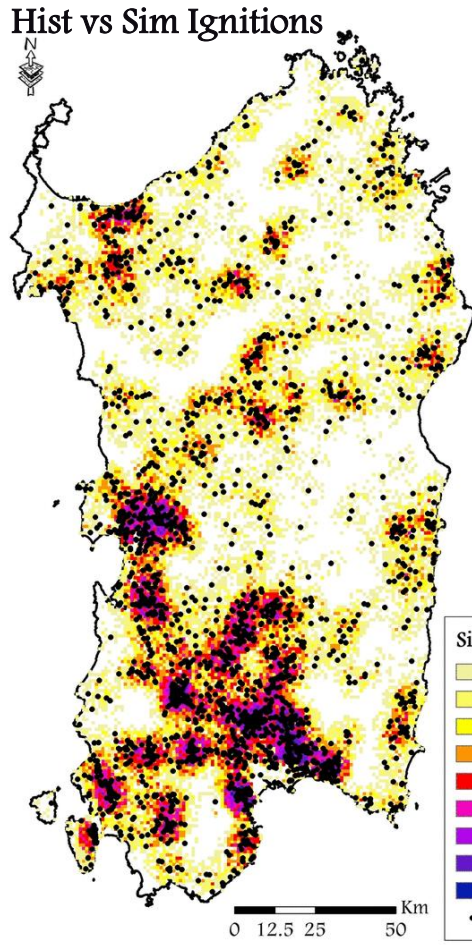
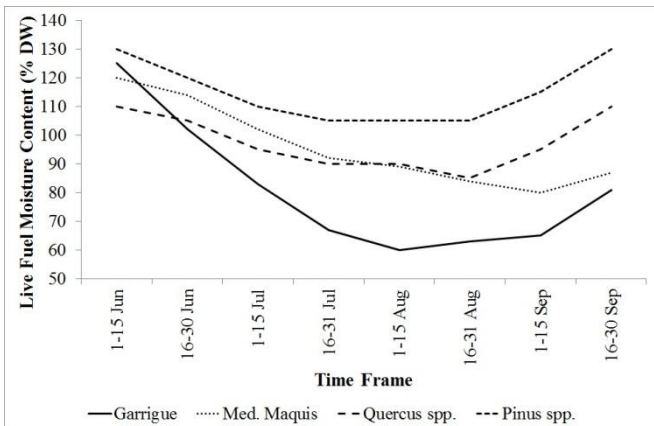
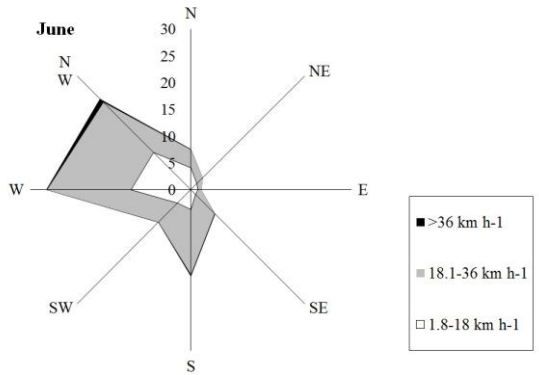

Tools to assess wildfire issues

Main Goal

Fire spread and behaviour modeling



Main Applications

- ~ fire spread and behaviour projections using future scenarios
- ~ assessing fire mitigation strategies (prescribed fires, fuel reduction, etc.)
- ~ quantifying fire exposure and risk
 - ~ identification of hot-spots

Fire danger modeling



- ~ daily/seasonal fire danger forecast
- ~ fire danger projections with future scenarios
 - ~etc

Fire Danger

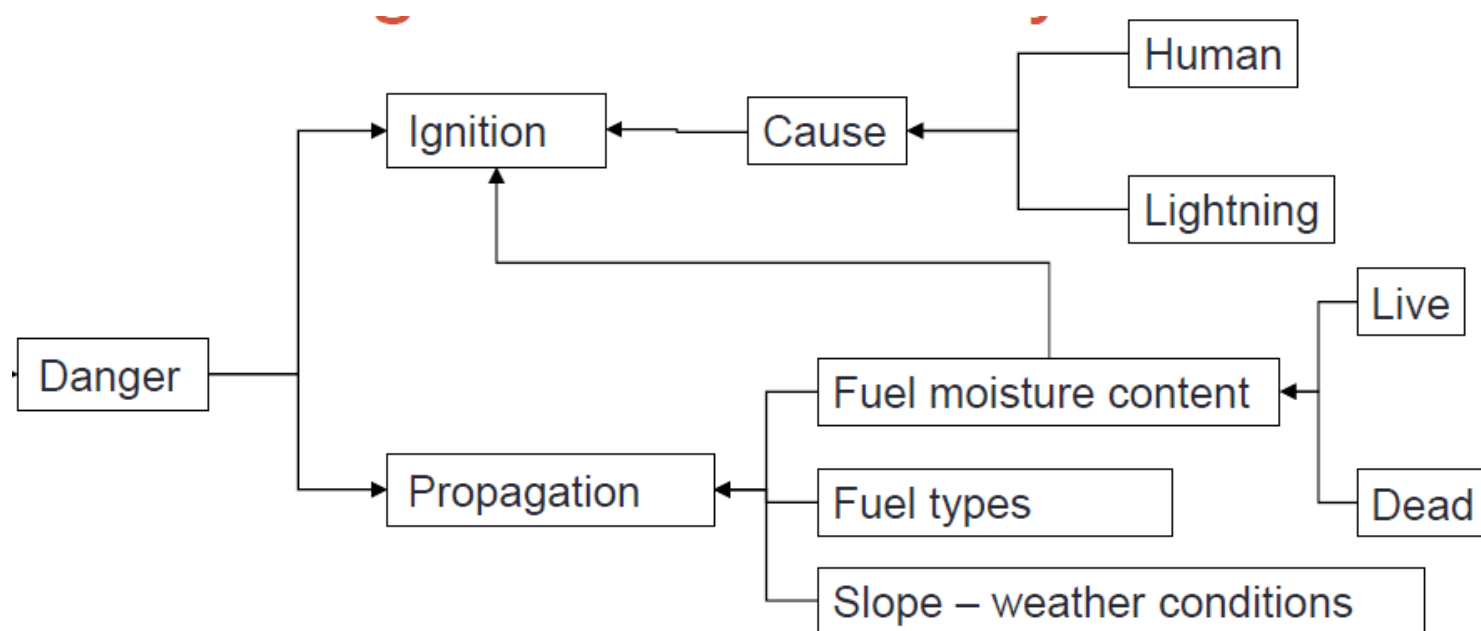

Fire danger aims to assess the ease of ignition, the rate of spread, and the difficulty of fire suppression considering as input a set of fixed and variable factors of the fire environment for a given area

Fire Danger

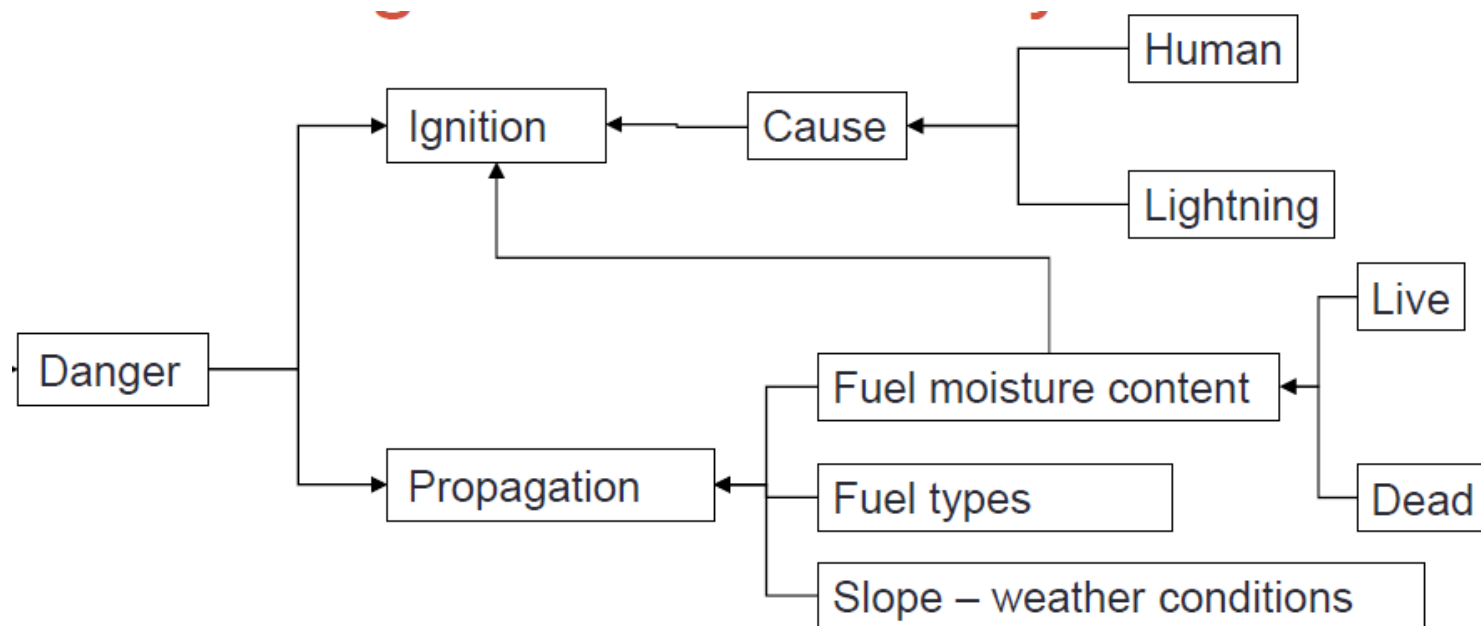

- Fire Ignition Danger ~ due to the combination of factors that can lead to the occurrence of a fire (e.g.: fuel moisture; lightning)
- Fire Propagation Danger ~ due to the combined presence of factors that favor the fire spread (e.g.: wind speed; fuel load)

Fire Danger

What is Fire Danger Index?

- i) A quantitative indicator of one or more facets of fire danger, expressed in classes, in relative or absolute value
- i) Estimating fire danger involves identifying the potentially contributing variables (i.e., weather) and integrating them into a mathematical expression

Fire danger rating

Variables influencing fire danger
weather, fuel, topography



Empirical or Theoretical integration
of these variables

The process of systematically evaluating and integrating the factors influencing fire danger, represented in the form of fire danger indices

Fire Danger

Input	Aims/applications	Time windows	Input data reliability
Historical data	<ul style="list-style-type: none"> •Retrospective analysis •Calibration/validation •Weather – FD - fire occurrence relationship 	From hourly to yearly	****
Short term forecast	<ul style="list-style-type: none"> •Active fire-fighting •Near real time simulations •Day-to-day strategies •Prescribed fires 	from hourly up to 7 days	***
Seasonal forecast	<ul style="list-style-type: none"> •Medium term fire management strategies at local-regional scale •Fuel management plans 	From monthly to season	**
Climate projections	<ul style="list-style-type: none"> •Long term fire regime and fire impacts estimation •Regional-global policies 	10 up to 100 years	*

Fire Danger

USA National Fire Danger Rating System

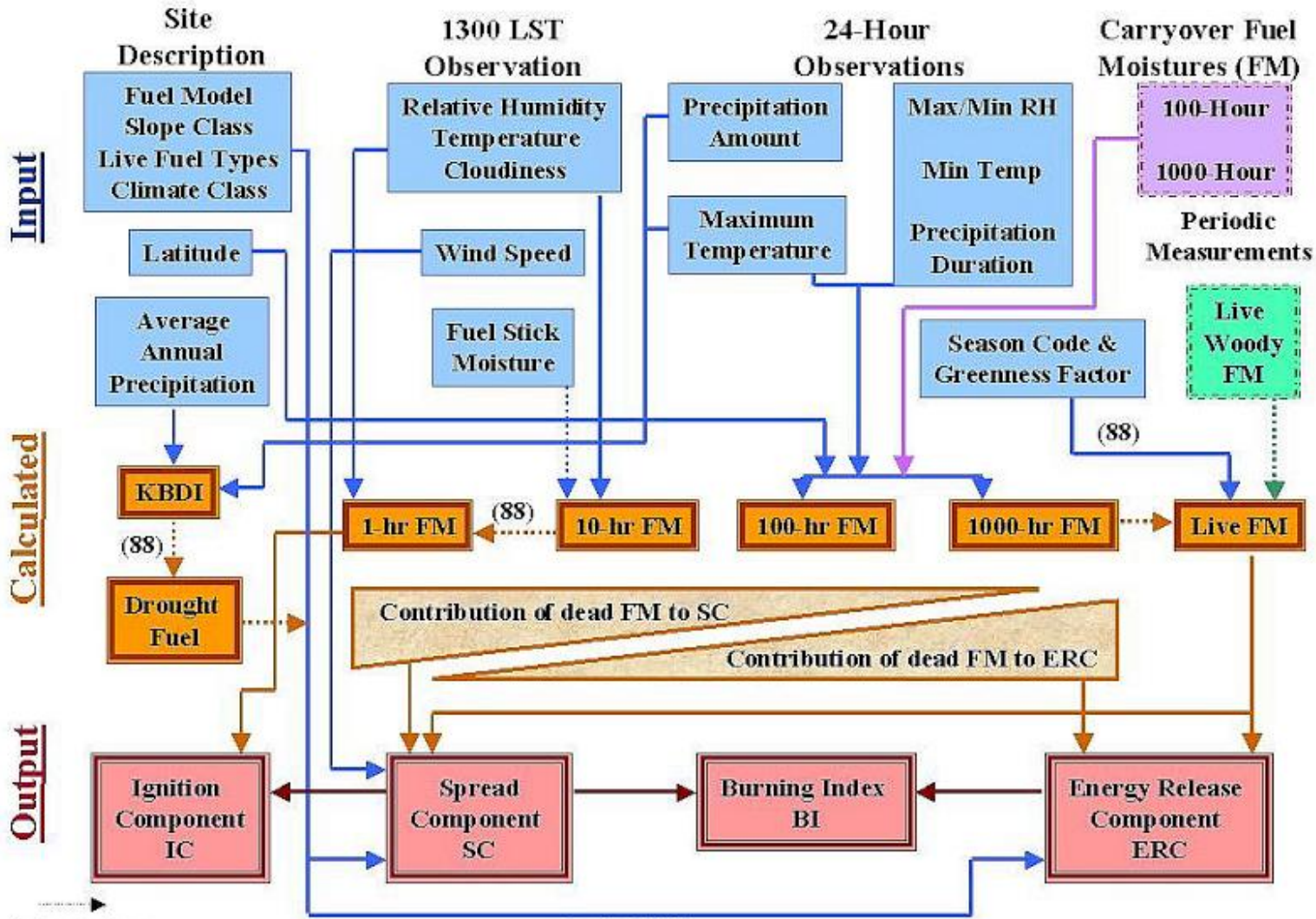

Optional pathway

September 19, 2000

Fire Danger

USA National Fire Danger Rating System

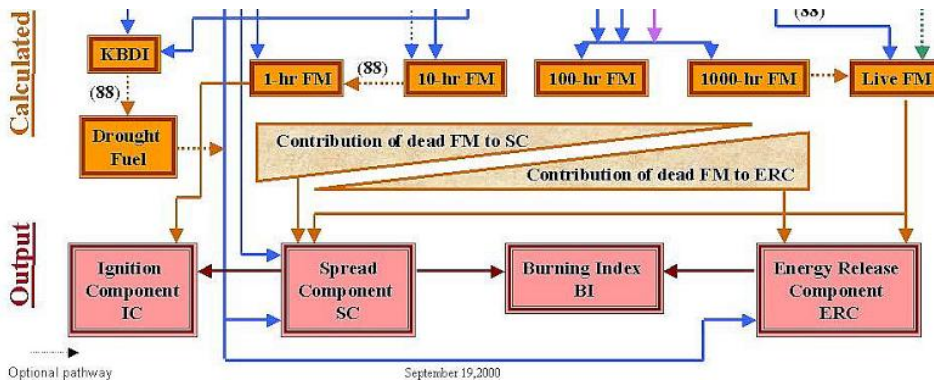

Keetch-Byram Drought Index (KBDI)

- Not an output of the National Fire Danger Rating System, but often used;
- Stand-alone index that measures the effects of seasonal drought on fire potential;
- The actual numeric value is an estimate of the amount of precipitation needed to bring the soil back to saturation (a value of 0 is complete saturation of the soil);
- The KBDI relationship to fire danger is that as the index value increases, the vegetation is subjected to increased stress due to moisture deficiency; at higher values desiccation occurs and live plant material is added to the dead fuel loading on the site

Fire Danger

USA National Fire Danger Rating System

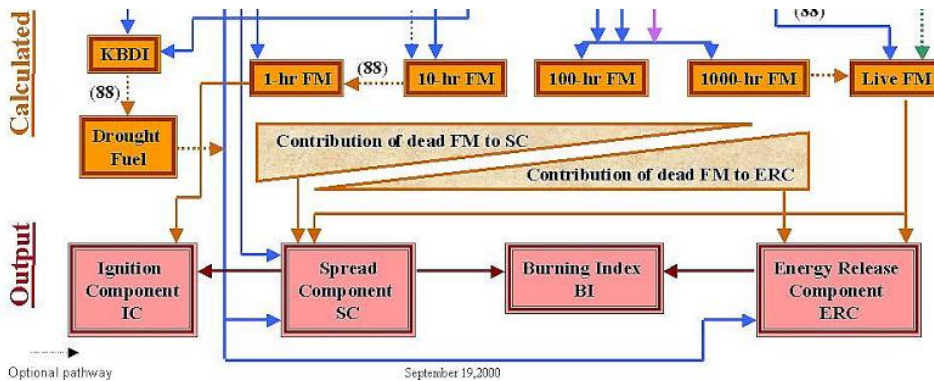

Ignition Component (IC)

- A rating of the probability that a firebrand will cause a fire requiring suppression action;
- Expressed as a probability, it ranges on a scale of 0 to 100;
- An IC of 100 means that every firebrand will cause an “actionable” fire if it contacts a receptive fuel. Likewise an IC of 0 would mean that no firebrand would cause an actionable fire under those conditions

Fire Danger



USA National Fire Danger Rating System

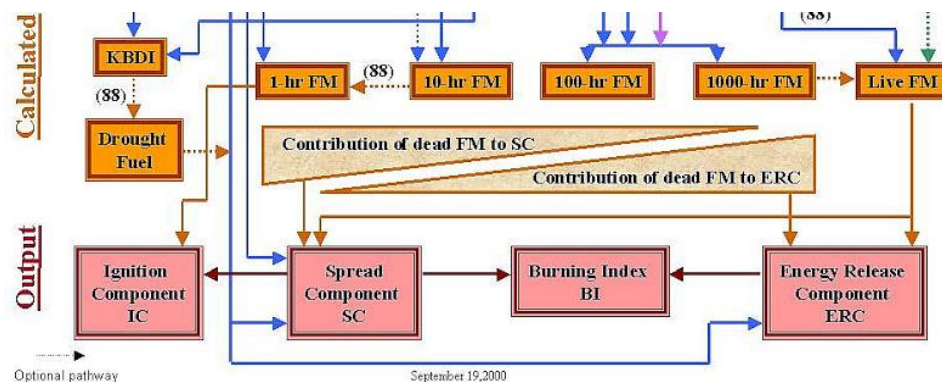

Spread Component (SC)

- A rating of the forward rate of spread of a headfire;
- Is numerically equal to the theoretical ideal rate of spread expressed in feet-per-minute

Fire Danger

USA National Fire Danger Rating System

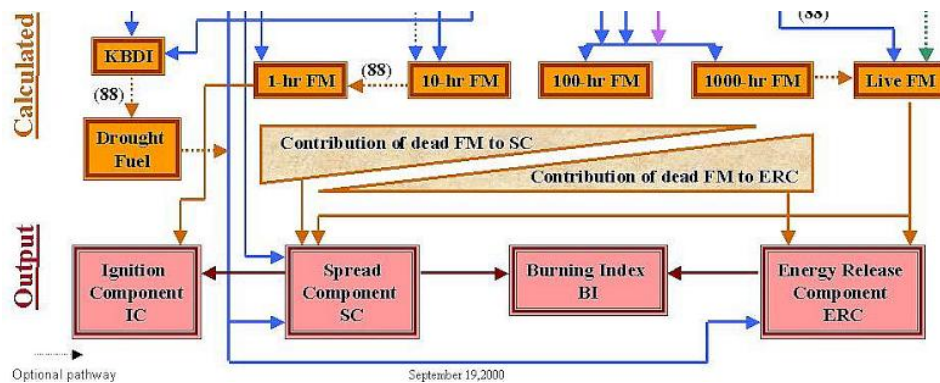

Energy Release Component (ERC)

- A number related to the available energy per unit area within the flaming front at the fire head: it represents the potential “heat release” per unit area;
- Daily variations in ERC are due to changes in moisture content of the various fuels present, both live and dead;
- It may be considered a composite fuel moisture value as it reflects the contribution that live and dead fuels have to potential fire intensity;
- Is a cumulative or “build-up” type of index. As live fuels cure and dead fuels dry, the ERC values get higher thus providing a good reflection of drought conditions.

Fire Danger

USA National Fire Danger Rating System

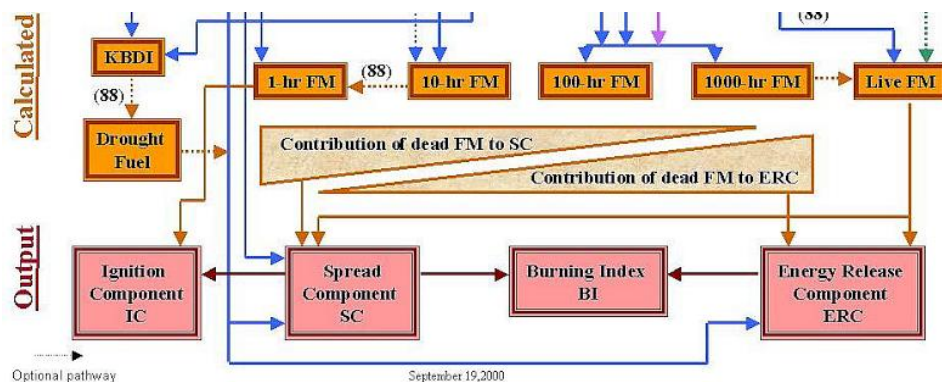

Burning Index (BI)

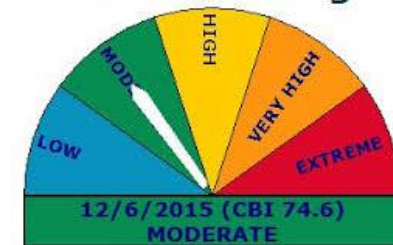

- A number related to the contribution of fire behavior to the effort of containing a fire;
- Derived from a combination of SC and ERC;
- Is expressed as a numeric value closely related to the flame length and fireline intensity

Fire Danger

USA National Fire Danger Rating System

USFS - WFAS
Wildland Fire Assessment System



Main Menu

- Home
- News
- Support
- Processing
- Disclaimer
- References
- Quick Links
- Search Archive

Fire Potential / Danger

- Fire Danger Rating
- Class Rating
- Fire Danger Subsets
- Haines Index
- Dry Lightning
- Potential Lightning
- Ignition
- Lightning Efficiency
- NDFD Fire Danger
- Forecasts

Weather

- Fire Weather
- Map Data
- Google Earth Map Data

Moisture / Drought

- Dead Fuel Moisture
- Growing Season Index
- AVHRR NDVI
- Keetch-Byram Index
- Palmer Index
- National Fuel Moisture

Fire Danger Rating

Fire Potential / Fire Danger Maps	Current Conditions	Forecast	Image Archive	Data Archive
Fire Danger Rating	US48 AK US48 Regional Subsets KML KMZ	US48	US48	

A Fire Danger Rating level takes into account current and antecedent weather, fuel types, and both live and dead fuel moisture ([Deeming and others 1977](#), [Bradshaw and others 1984](#)).

The [adjective class rating](#) is a method of normalizing rating classes across different fuel models, indexes, and station locations. It is based on the primary fuel model cataloged for the station, the fire danger index selected to reflect staffing levels, and climatological class breakpoints. This information is provided by local station managers. About 90% use the Burning Index (BI); others use Energy Release Component (ERC). Staffing class breakpoints are set by local managers from historical fire weather climatology.

Only reporting station locations are indicated with a marker on the maps. Values between stations are estimated with an inverse distance-squared technique on a 10-km grid. This works pretty well in areas of relatively high station density, but has obvious shortcomings in other areas.

[< Prev](#)

[Next >](#)

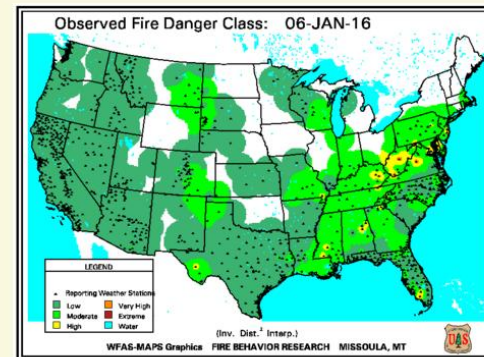
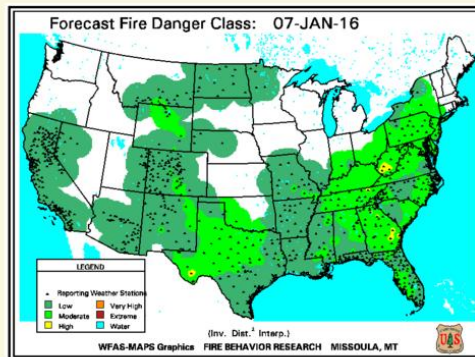

Fire Danger

Canadian Fire Weather Index

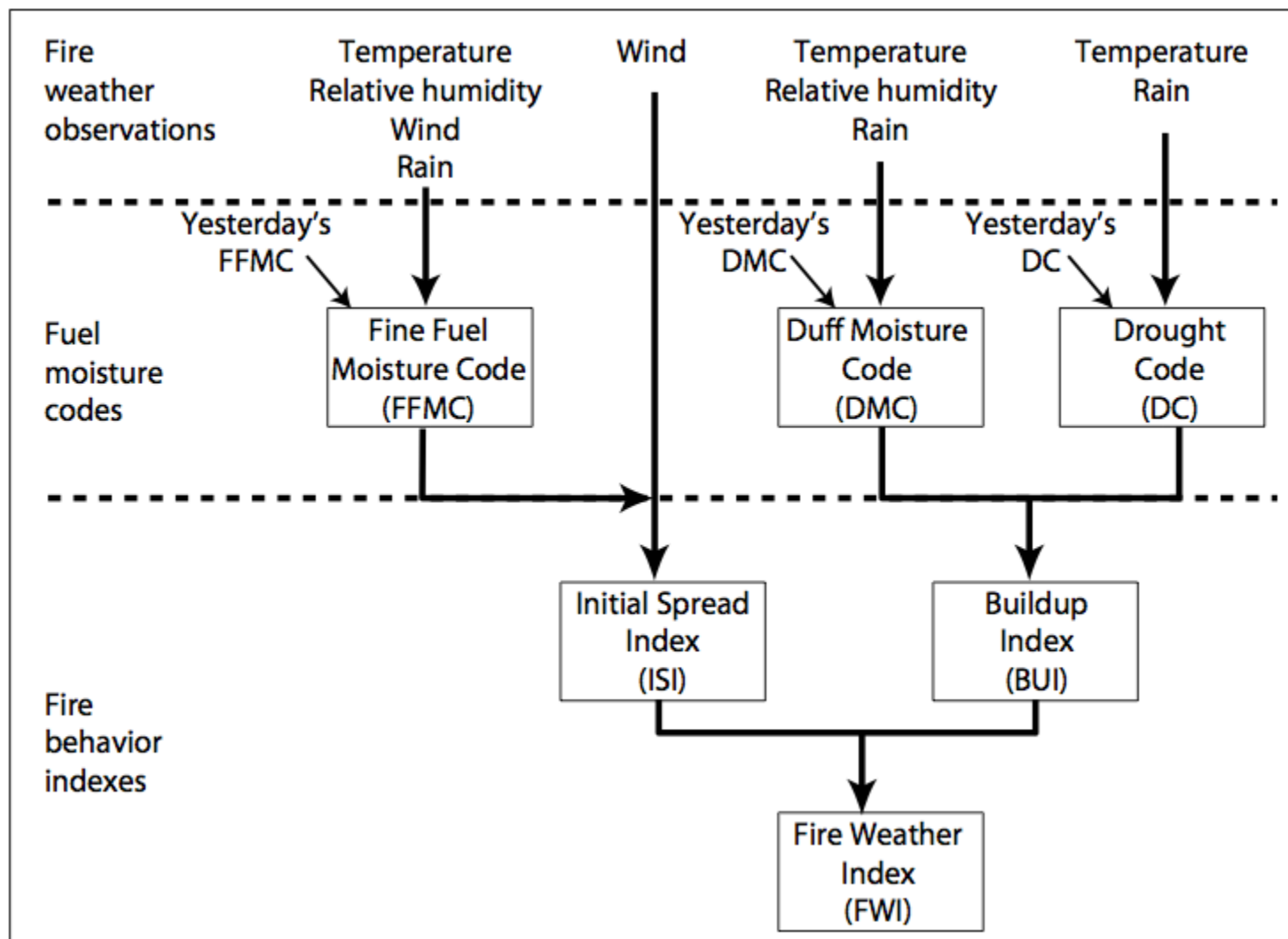

Fire Danger



Canadian Fire Weather Index

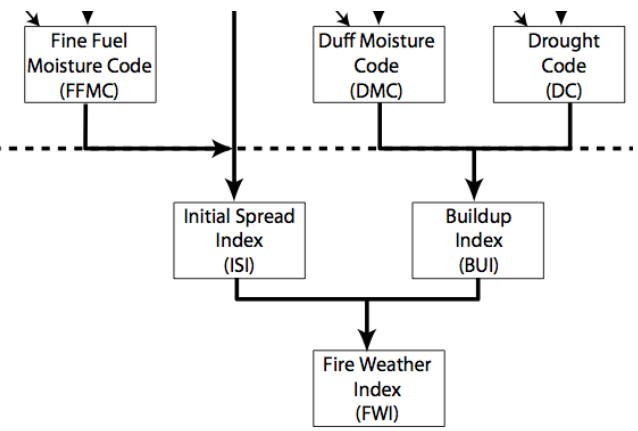

Fine Fuel Moisture Code (FFMC)

- ❖ Represents the fuel moisture of forest litter fuels under the shade of a forest canopy;
- ❖ It is intended to represent moisture conditions for the equivalent of 16-hour timelag fuels;
- ❖ It ranges from 0 to 101.

Fire Danger

Canadian Fire Weather Index

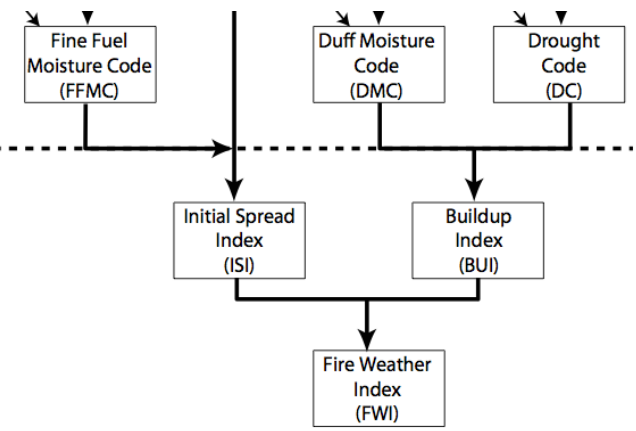

Duff Moisture Code (DMC)

- ❖ Represents the fuel moisture of decomposed organic material underneath the litter;
- ❖ Represents moisture conditions for the equivalent of 15-day (or 360 hr) timelag fuels;
- ❖ Is unitless and open ended;
- ❖ It may provide insight to live fuel moisture stress.

Fire Danger



Canadian Fire Weather Index

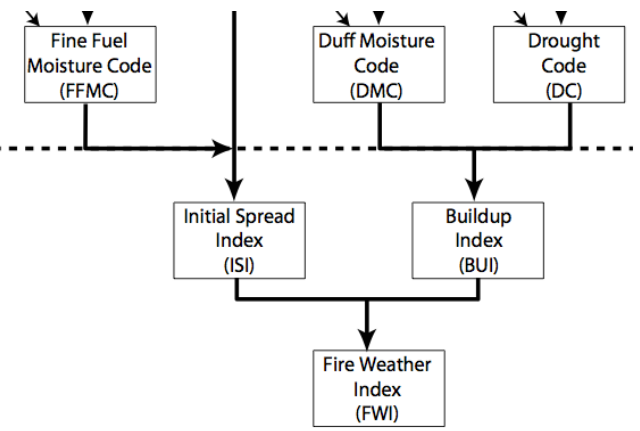

Drought Code (DC)

- ❖ Like the KBDI, represents drying deep into the soil
- ❖ It approximates moisture conditions for the equivalent of 53-day (1272 hour) timelag fuels
- ❖ It is unitless, with a maximum value of 1000

Fire Danger



Canadian Fire Weather Index

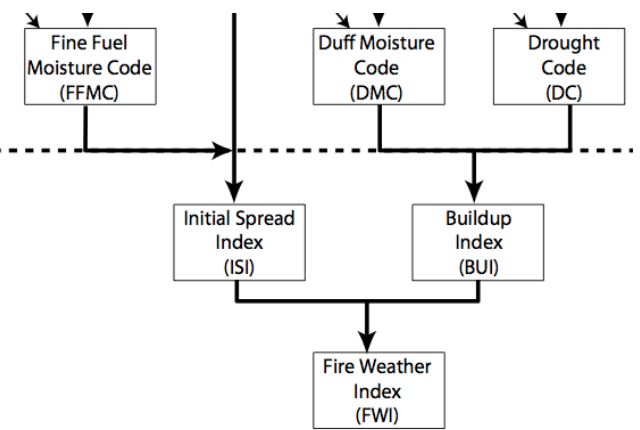

Initial Spread Index (ISI)

- ❖ Is analogous to the NFDRS Spread Component (SC);
- ❖ Integrates fuel moisture for fine dead fuels and surface windspeed to estimate a spread potential;
- ❖ Is unitless

Fire Danger



Canadian Fire Weather Index

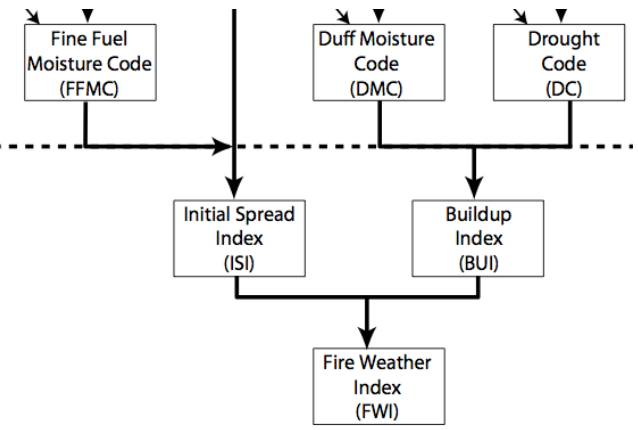

Buildup Index (BUI)

- ❖ Is analogous to the NFDERS Energy Release Component (ERC);
- ❖ Combines the current DMC and DC to produce an estimate of potential heat release in heavier fuels;
- ❖ Is unitless

Fire Danger

Canadian Fire Weather Index

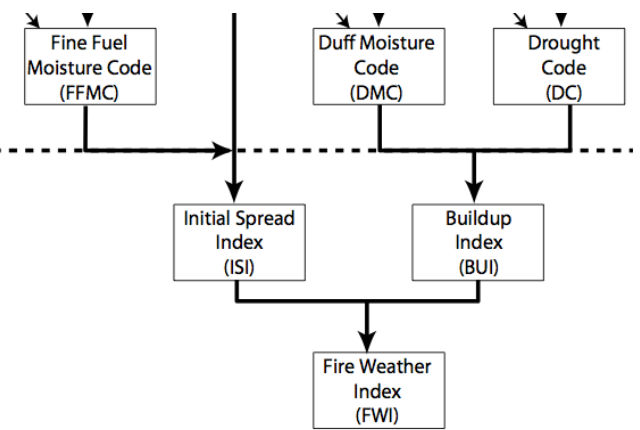

Fire Weather Index (FWI)

Fire Weather Index

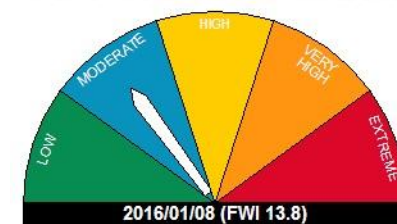

- ❖ Integrates current ISI and BUI to produce a unitless index of general fire intensity potential

Fire Danger

Canadian Fire Weather Index

Fire Weather Maps

[Previous day](#)
[Today](#)
[Next day](#)

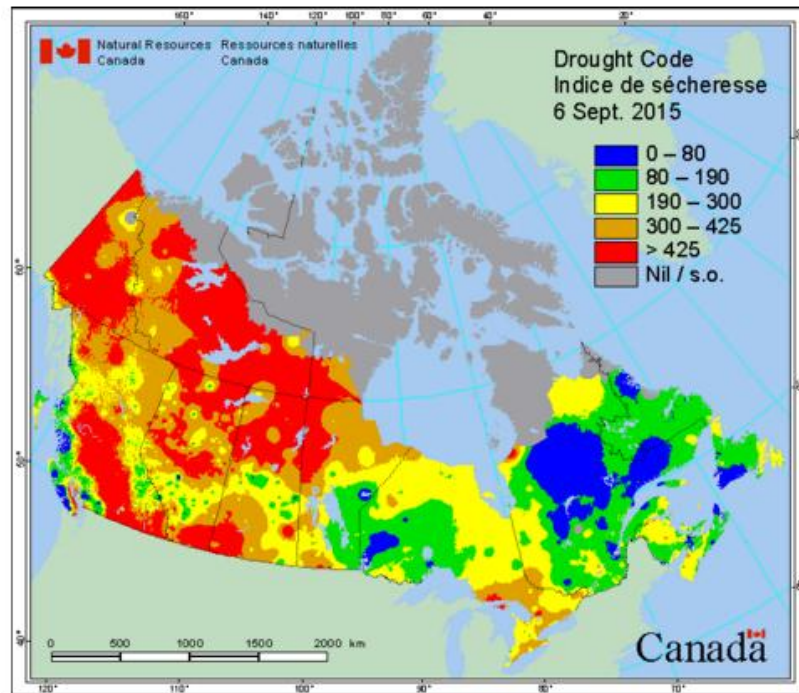

Energy | Mining/Materials | Forests | Earth Sciences | Hazards | Explosives | The North | Environment

Home → Forests → Forest Topics → Fire → CWFIS → Maps and Reports → Fire Weather Maps

Canadian Wildland Fire Information System

Fire Weather Maps

[Previous day](#)
[Today](#)
[Next day](#)

Fire Danger is a relative index of how easy it is to ignite vegetation, how difficult a fire may be to control, and how much damage a fire may do.
 Note: These general fire descriptions apply to most coniferous forests. Choice and interpretation of classes may vary between provinces. For fuel-specific fire behavior, consult the Fire Behavior Prediction maps.

- Forests
- CWFIS
- Background Information
- Maps and Reports
- Interactive map
- Current Conditions
- Fire Danger
- Weather
- Fire Weather
- Fire Behavior
- Fire M3 Hotspots
- Fire Occurrence Prediction
- Monthly and Seasonal Forecasts
- National Wildland Fire Situation Report
- Historical Analysis
- Fire Weather Normals
- Fire Behavior Normals
- Canadian National Fire Database
- CWFIS Datamart
- Publications

Status	Description
Low	Fires likely to be self-extinguishing and new ignitions unlikely. Any existing fires limited to smoldering in deep, drier layers.
Moderate	Creeping or gentle surface fires. Fires easily contained by ground crews with pumps and hand tools.
High	Moderate to vigorous surface fire with intermittent crown involvement. Challenging for ground crews to handle; heavy equipment (bulldozers, tanker trucks, aircraft) often required to contain fire.
Very High	High-intensity fire with partial to full crown involvement. Head fire conditions beyond the ability of ground crews; air attack with retardant required to effectively attack fire's head.
Extreme	Fast-spreading, high-intensity crown fire. Very difficult to control. Suppression actions limited to flanks, with only indirect actions possible against the fire's head.

Fire Danger

European Forest Fire Information System (EFFIS)

Definition and scope of EFFIS

- System established by the Joint Research Centre (JRC) and DG Environment (ENV) as focal point for information on forest fires in Europe (1998)
- Provides EU level assessments during both pre-fire and post-fire phases, thus supporting fire prevention, preparedness, fire fighting and post-fire operations
- Complements national fire information systems through the provision of harmonised data, methods and standards

Users

- EC Services, European Parliament, national/regional forest fires and civil protection services of EU and non-EU countries
- FAO, United Nations Economic Commission for Europe, FAO *Silva Mediterranea*

Fire Danger

European Forest Fire Information System (EFFIS)

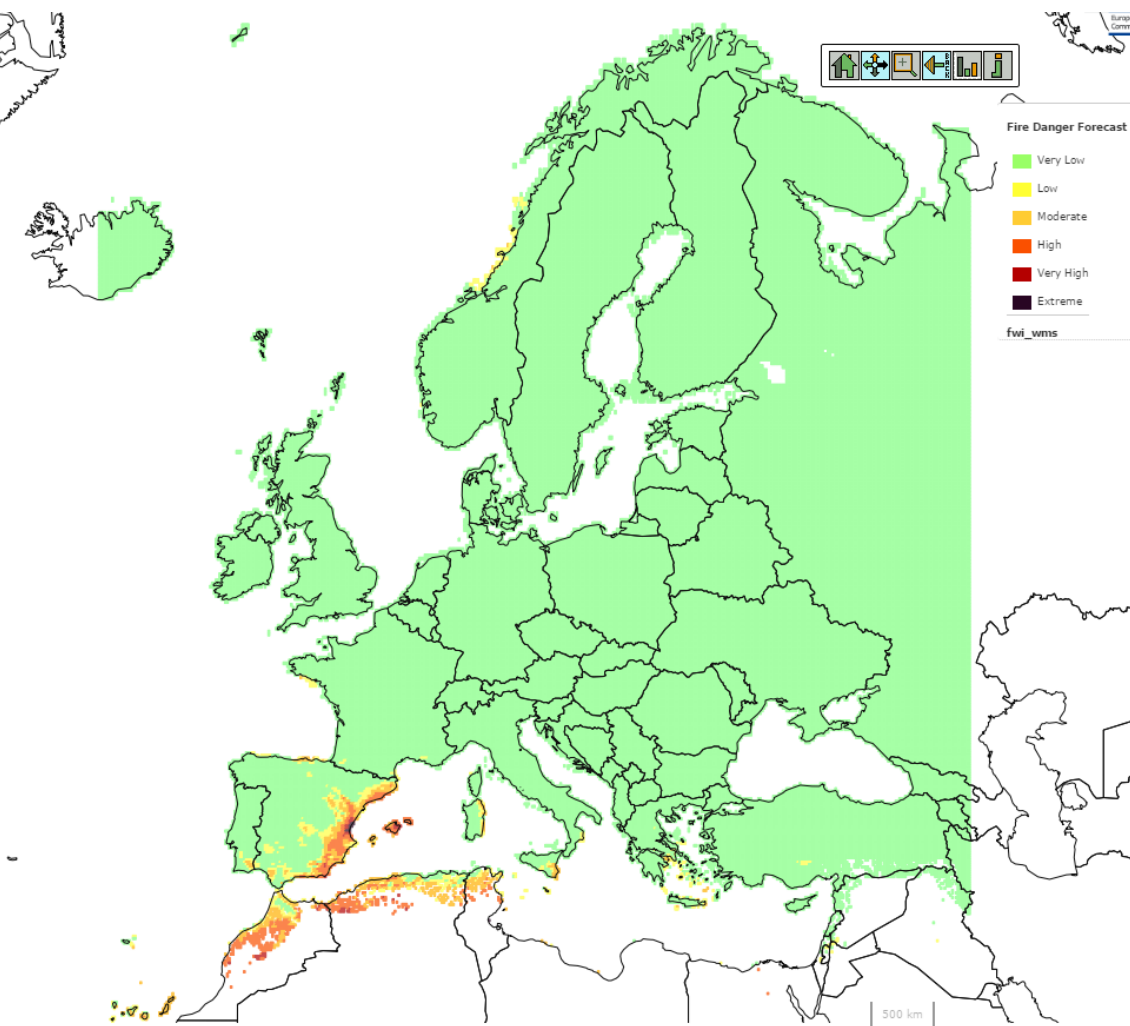

There are currently **38 countries** involved in the EFFIS network: Albania, Algeria, Austria, Belgium, Bulgaria, Croatia, Cyprus, Czech Republic, Estonia, Finland, France, Former Yugoslavian Republic of Macedonia, Germany, Greece, Hungary, Ireland, Italy, Kosovo, Latvia, Lebanon, Lithuania, Montenegro, Morocco, Netherlands, Norway, Poland, Portugal, Romania, Russia, Serbia, Slovakia, Slovenia, Spain, Sweden, Switzerland, Tunisia, Turkey and the United Kingdom.

Fire Danger

European Forest Fire Information System (EFFIS)

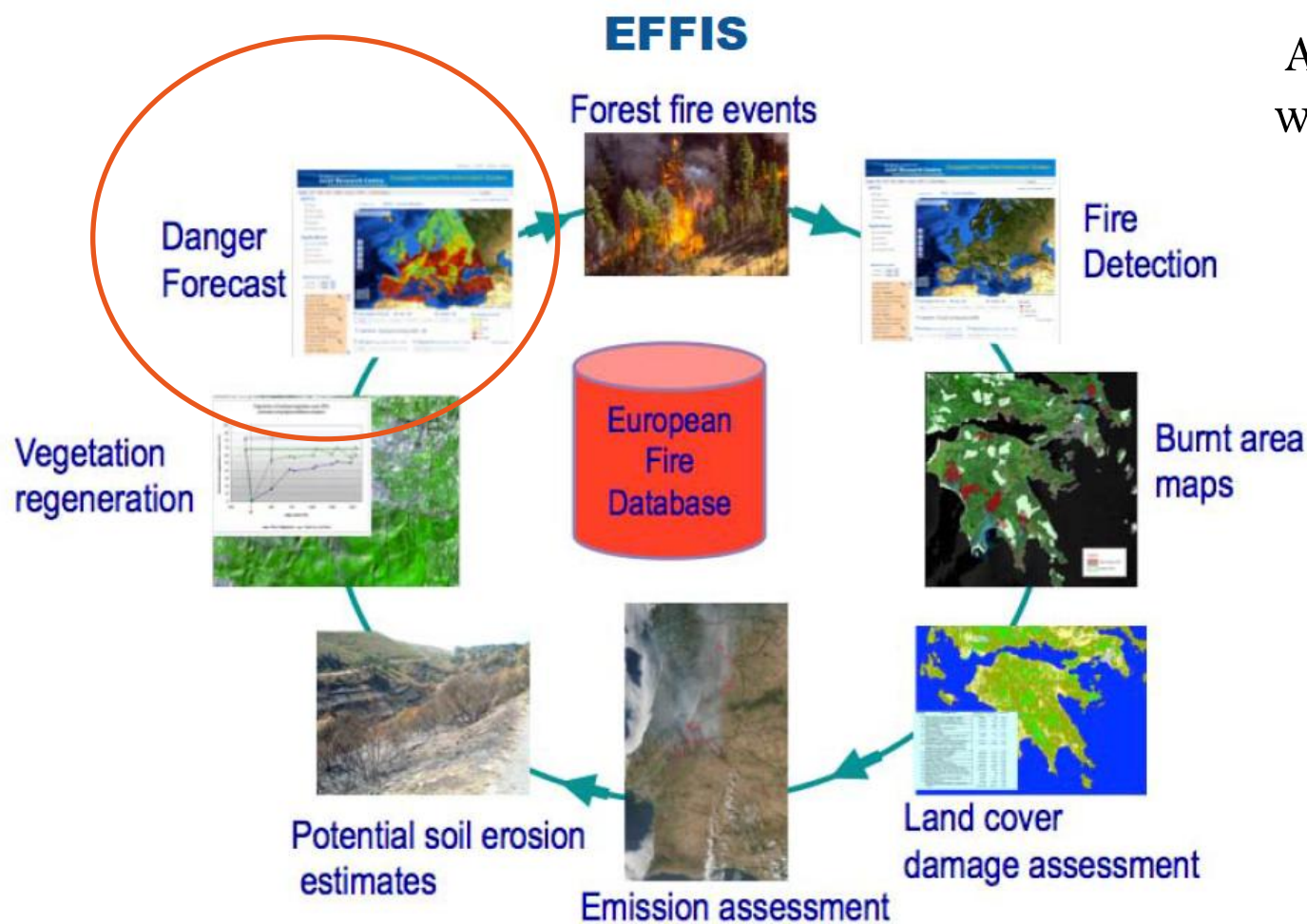

A web based platform with different modules (www.effis.jrc.it)

Fire Danger

European Forest Fire Information System (EFFIS)

- In EU there is a relative young tradition in FDR and many different approaches
- The fire danger rating module of EFFIS has been established as unified platform for implementing at the EU scale selected national indices
- The main motivation was having a common system to support preparedness and cooperation among EU countries
- The Canadian FWI has been adopted since 2007

Fire Danger

European Forest Fire Information System (EFFIS)

The fire danger forecast module of EFFIS generates daily maps of 1 to 6 days projected fire danger in EU using weather forecast data.

PERIOD: from 16th of February to 31st of October

DATA: meteorological forecasted data received daily

From Meteo-France

Spatial resolution of 10km

Forecast up to 4 days

From DWD (Deutscher Wetterdienst)

Spatial resolution of 25km

Forecast up to 7 days

From ECMWF

Spatial resolution of 16km

Forecats up to 8 days



Fire Danger

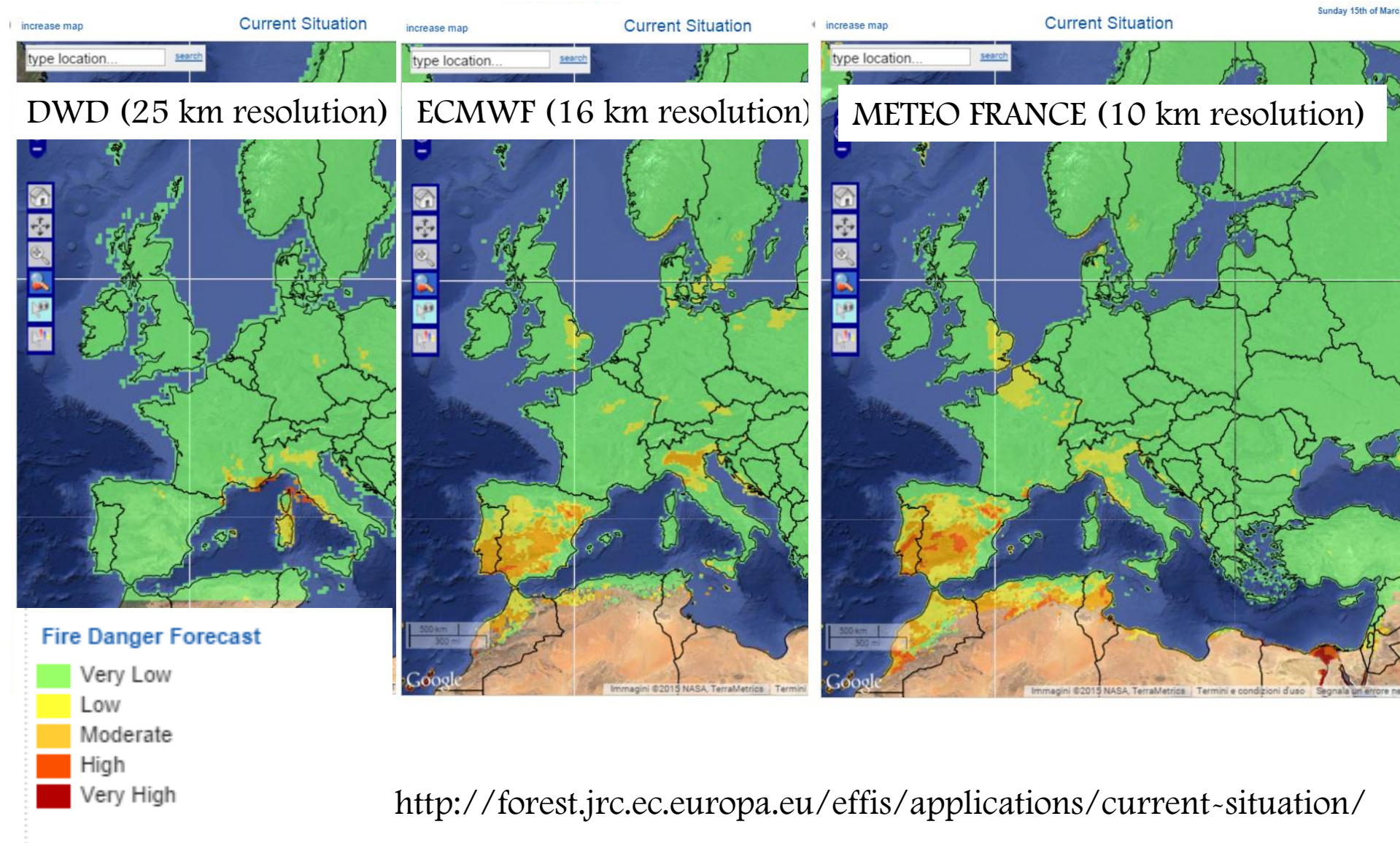

Fire Danger

European Forest Fire Information System (EFFIS)

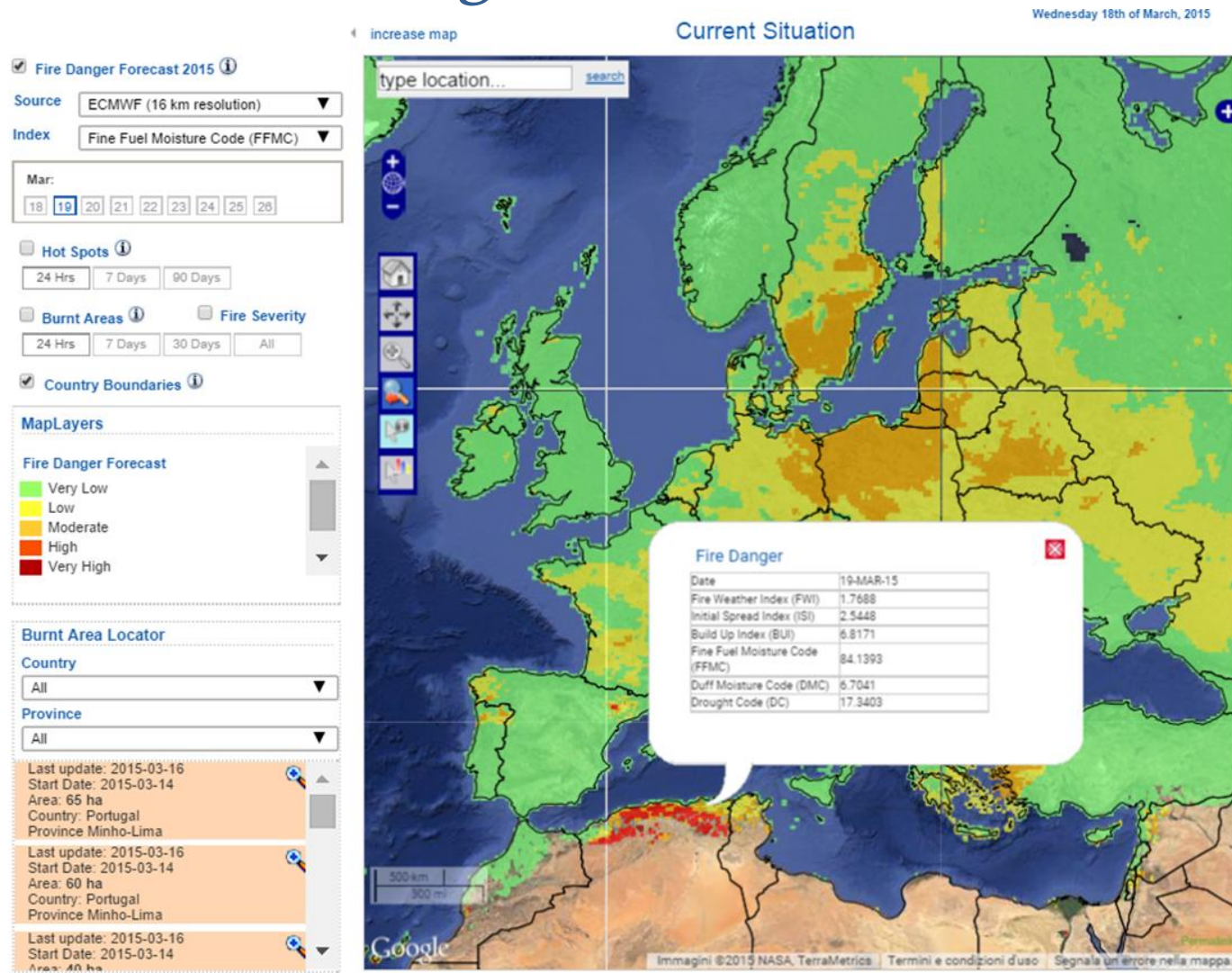

<http://forest.jrc.ec.europa.eu/effis/applications/current-situation/>

Fire Danger

Integrated Fire Danger Index (IFI)

- Developed in Sardinia (Italy) by the University of Sassari
- Daily fire danger outputs used in an operative version by the Civil Protection of Sardinia for fire monitoring and alerts
- Fire danger is a unitless value ranging from 0 to 18. High values indicate high fire danger
- Fire danger is commonly expressed in classes ranging from 1 (very low) to 5 (extreme)

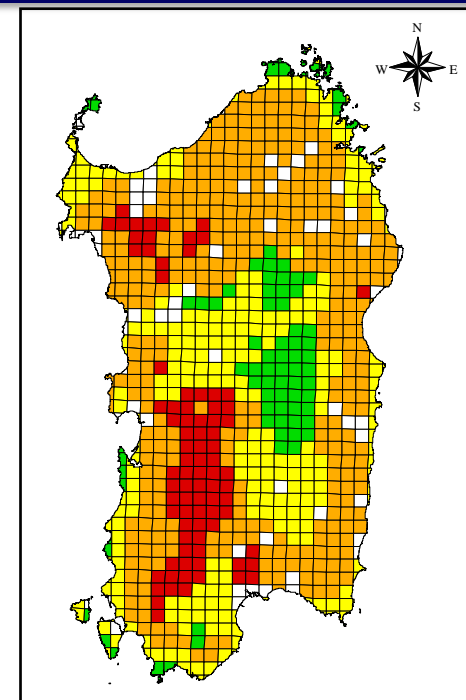
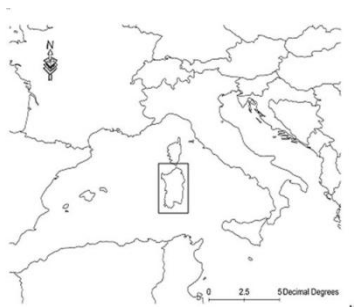

IFI danger classes

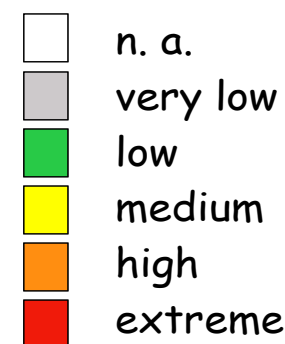

Fire Danger

Integrated Fire Danger Index (IFI)

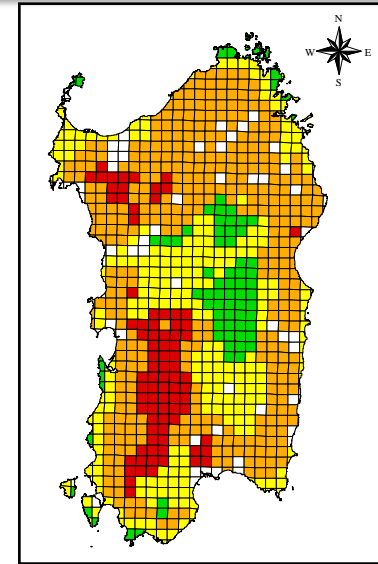
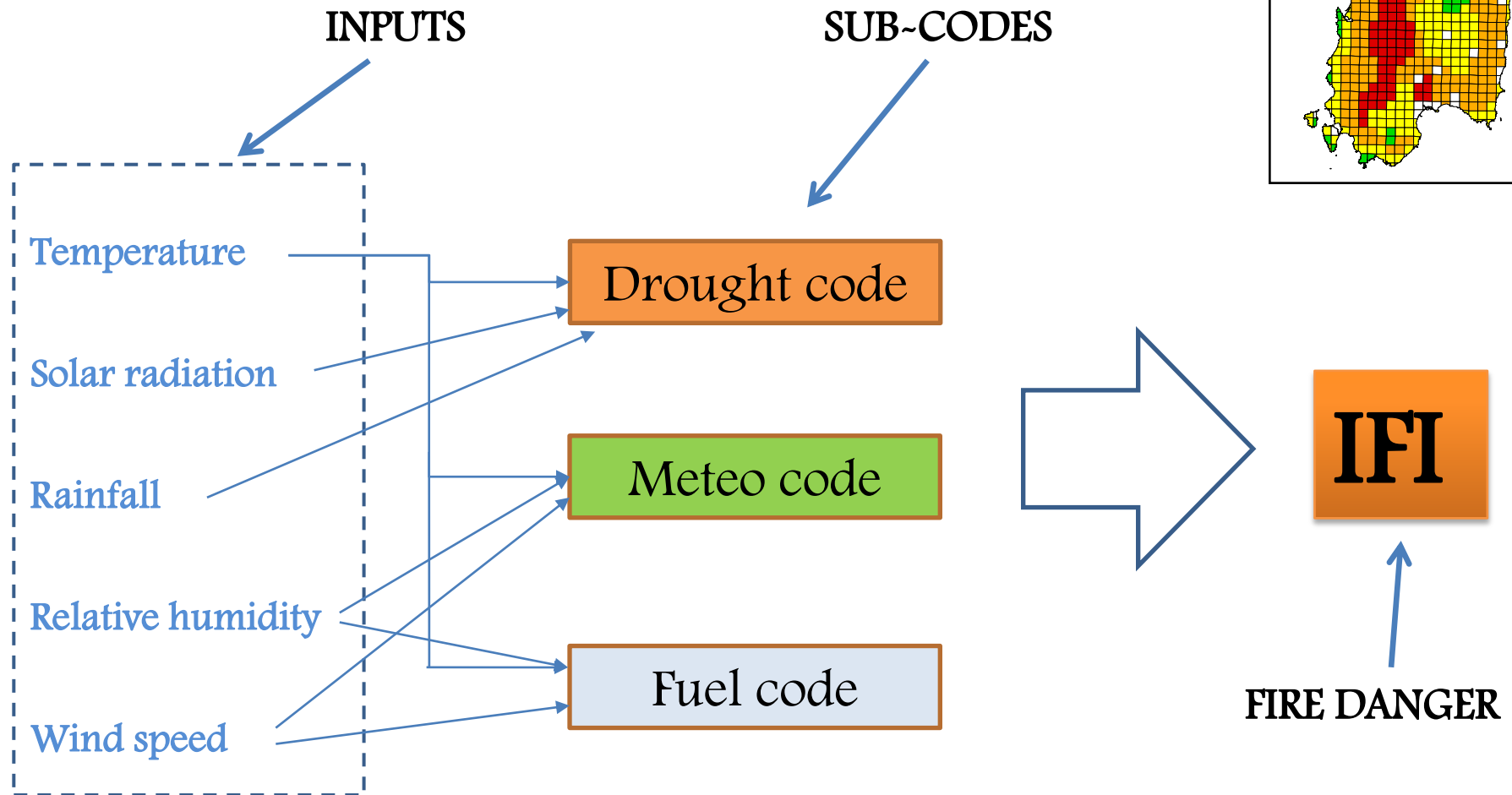

Fire Danger

Integrated Fire Danger Index (IFI)

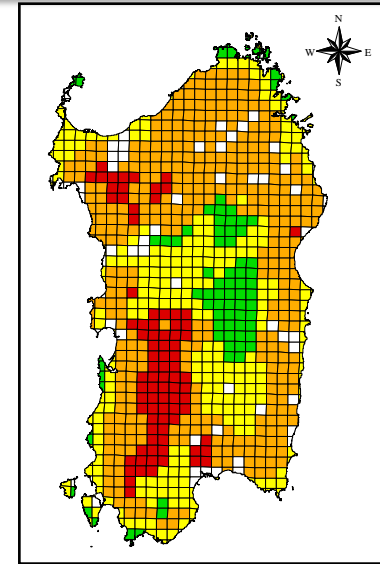

Indicator of the soil dryness

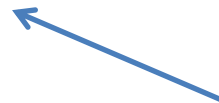

Drought code

Indicator of the fuel moisture conditions

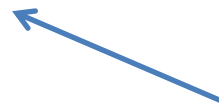

Meteo code

Fuel code



Indicator of the fire weather severity

Thank you for your attention!

Michele Salis (miksalis@uniss.it)